



DL4

DuraPlex™ Lavalier Microphones

The Shure DuraPlex Lavalier online user guide.
Version: 0.3 (2020-J)

Table of Contents

DL4 DuraPlex™ Lavalier Microphones	3	Threaded Mount Instructions	6
General Description	3	Accessories	7
Features	3	Furnished Accessories	7
Care and Maintenance	3	Optional Accessories	7
		Replacement Parts	8
DuraPlex Accessories	3	Wiring and Termination	9
Presence Cap	4	Typical Wiring Table	9
Attaching the Windscreen	4	MTQG Connector Assembly	10
Tie Clip	5	Specifications	11
Dual Tie Clip	6	Frequency Response	12
Sticky Mount	6	Certifications	12
Lavalier Distance	6		

DL4 DuraPlex™ Lavalier Microphones

General Description

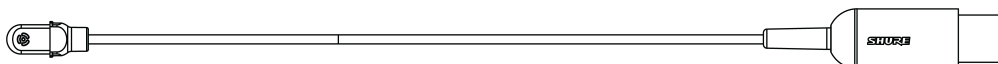

The Shure DuraPlex DL4 is a professional MEMS condenser lavalier microphone that is ideal for both speech and performance applications in challenging environments. The IP57 rated omnidirectional lavalier is dust resistant and waterproof, manufactured for use in applications that require extended durability, uncompromised sound quality, and reliability. The subminiature design and various mounting options provide discrete placement in applications for film, television, education, and corporate events. Each microphone is supplied with a storage pouch, single tie clip, sticky vocal presence frequency response cap, snap fit windscreen, foam windscreen, and TA4F threaded adapter.

Features

- IP57 Certified dust resistant and waterproof/sweatproof headset
- 5mm omnidirectional subminiature design for discrete placement and improved gain before feedback
- 1.6mm PLEX Cable technology, paintable cable, and no memory effect
- Professional sound quality for speech and performance applications
- High RF immunity, compatible with digital wireless systems without RF interference
- Attachable Presence Cap included for tailored frequency response in speech applications
- Included furnished accessories for storage, mounting options, and wind protection
- TA4F and LEMO terminations for variable wireless system connectivity
- Included sticky mount (adhesive patch sold separately) for application requiring placement underneath clothing
- Available in Black, Tan, Cocoa finishes

Care and Maintenance

The DuraPlex omnidirectional microphone has been IP57 dust-protected, waterproof rated by extensive internal tests, so you can clean it using distilled water and a mild detergent when necessary.

DuraPlex Accessories

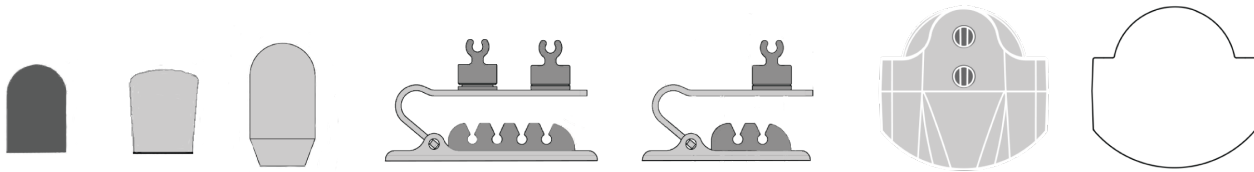

Presence Cap

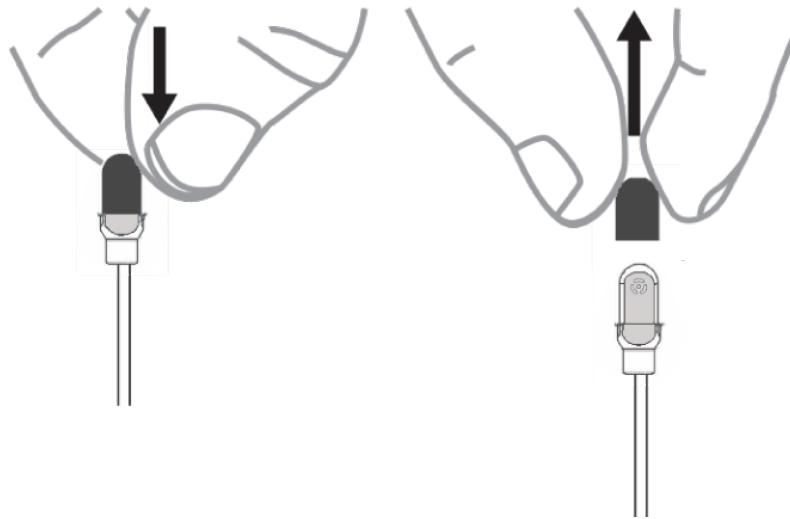

Frequency Response

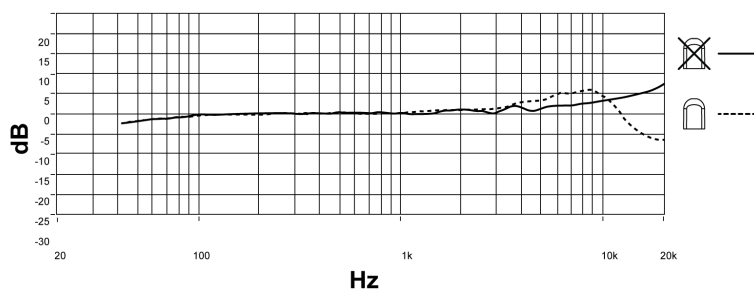

Attaching the Windscreen

There are two windscreens for use with the DuraPlex microphone:

1. A slide-fit windscreen for use with the presence cap

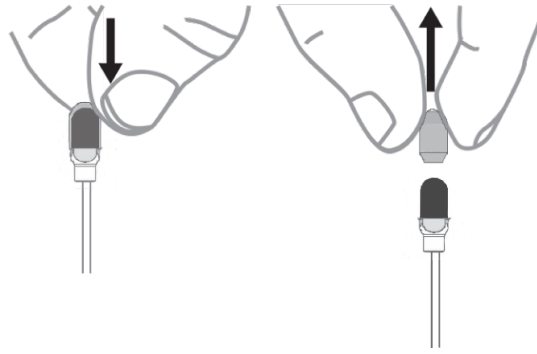

2. A snap-fit windscreen for use without the presence cap

Note: Do not use the snap-fit windscreen with the presence cap--the presence cap can become caught inside the snap-fit windscreen.

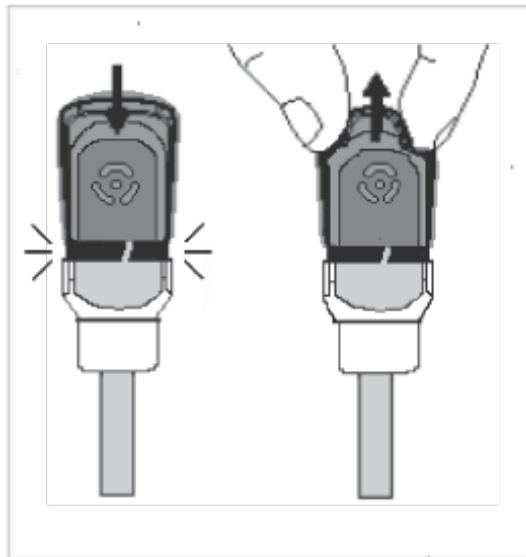

Tie Clip

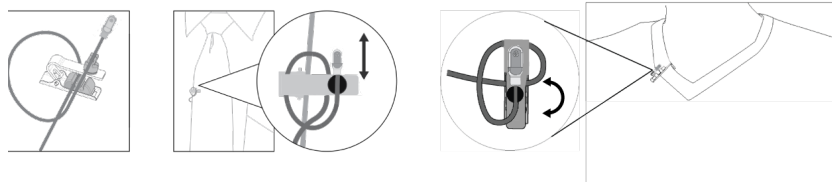

Dual Tie Clip



Sticky Mount

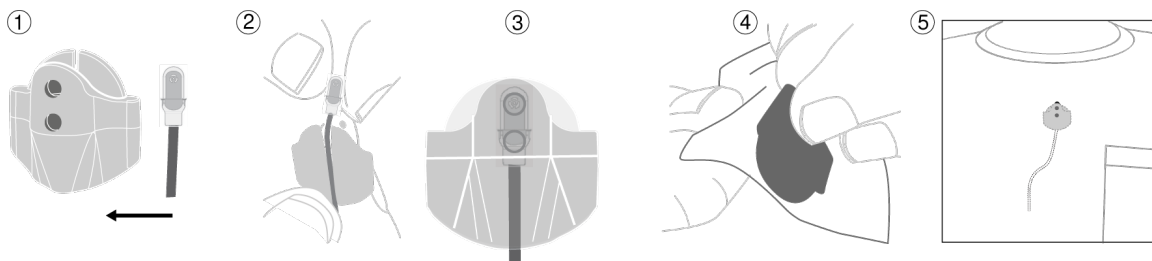

Lavalier Distance

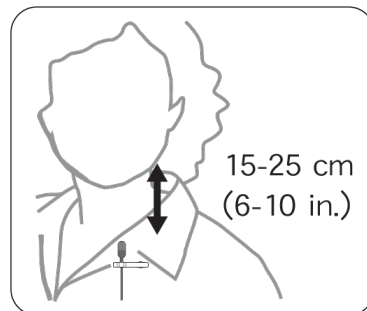

Threaded Mount Instructions

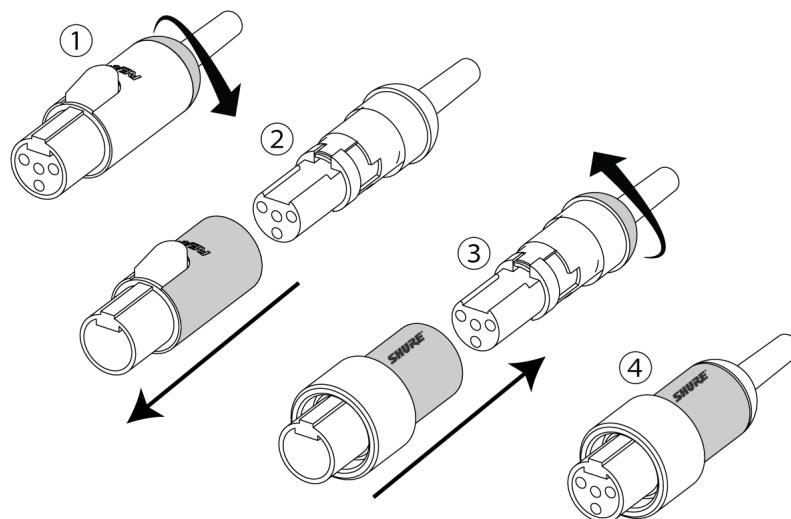

Accessories

Furnished Accessories

Furnished Accessories	DL4 Black	DL4 Tan	DL4 Cocoa	DL4 White
Single Tie Clip	95A43715	95C43715	95D43715	95A43715
Presence Cap	65A44182	65B44182	65C44182	65D44182
Snap-Fit Windscreen	95A16167	95B16167	95C16167	95D16167
Foam Windscreen	95A43438	95B43438	95C43438	95D43438
Sticky Mount	66A44183	66A44183	66A44183	66A44183
Case	95A44074	95A44074	95A44074	95A44074
Threaded TA4F Adapter	95A29490	95A29490	95A29490	95A29490

Accessories are available in Black (B), Tan (T), Cocoa (C), and White (W) color varieties. Please consult your Shure representative for available options.

Optional Accessories

Sticky Mount Adhesives (15 Pieces)	RPM40TS
Sticky Mount Adhesives (50 Pieces)	RPM40TS/50

TA4F/TQG XLR Preamp	RPM400TQG
Lemo XLR Preamp	RPM400LEMO
Black Dual Tie Clip, qty.1	95A44848
White Dual Tie Clip, qty.1	95B44848
Tan Dual Tie Clip, qty.1	95C44848
Cocoa Dual Tie Clip, qty.1	95D44848

Replacement Parts

RPMDL4WS/B	FOAM WINDSCREEN, BLACK, QTY. 5
RPMDL4WS/C	FOAM WINDSCREEN, COCOA, QTY. 5
RPMDL4WS/T	FOAM WINDSCREEN, TAN, QTY. 5
RPMDL4WS/W	FOAM WINDSCREEN, WHITE, QTY. 5
RPMDL4SFWS/B	DL4/DH5 SNAP FIT WINDSCREEN, BLACK, QTY 3
RPMDL4SFWS/C	DL4/DH5 SNAP FIT WINDSCREEN, COCOA, QTY 3
RPMDL4SFWS/T	DL4/DH5 SNAP FIT WINDSCREEN, TAN, QTY 3
RPMDL4SFWS/W	DL4/DH5 SNAP FIT WINDSCREEN, WHITE, QTY 3
RPMDL4STC/B	SINGLE TIE CLIP, BLACK, QTY. 3
RPMDL4STC/C	SINGLE TIE CLIP, COCOA, QTY. 3
RPMDL4STC/T	SINGLE TIE CLIP, TAN, QTY. 3
RPMDL4STC/W	SINGLE TIE CLIP, WHITE, QTY. 3

RPMDL4DTC/B	DUAL TIE CLIP, BLACK, QTY. 3
RPMDL4DTC/C	DUAL TIE CLIP, COCOA, QTY. 3
RPMDL4DTC/T	DUAL TIE CLIP, TAN, QTY. 3
RPMDL4DTC/W	DUAL TIE CLIP, WHITE, QTY. 3
RPMDL4FC/B	DL4/DH5 FREQ CAP, BLACK, QTY. 5
RPMDL4FC/C	DL4/DH5 FREQ CAP, COCOA, QTY. 5
RPMDL4FC/T	DL4/DH5 FREQ CAP, TAN, QTY. 5
RPMDL4FC/W	DL4/DH5 FREQ CAP, WHITE, QTY. 5
RPMDL4SM	DL4 STICKY MOUNT, QTY. 3
RPMDL4CASE	DL4 POUCH, LAVALIER

Wiring and Termination

Typical Wiring Table

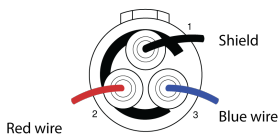
Series	Cable Construction	Electrical Design	Polarity	Replacement Connector	For Use With	Wiring	Line Art (From Solder Side)
DL4-LEMO	1.6mm cable with single conductor and shield	3 wire with additional bias on pin 3	Positive with respect to ground	WA416	Shure Lemo Bodypacks (AD1/ADX1-Lemo, Shure UR1M-Lemo, ULXD1-Lemo)	Red wire: Audio/Bias(2) Blue wire: Audio(3) Shield: Ground(1)	

Series	Cable Construction	Electrical Design	Polarity	Replacement Connector	For Use With	Wiring	Line Art (From Solder Side)
DL4-MTQG	1.6mm cable with 2 conductors, 2 shield wires and shield	3-Wire	Positive with respect to ground	WA430	All Shure TA4F Body-packs	Red wire: Bias(2) Blue wire: Audio(3) Shield wire: Ground(1) Shield: Ground (Shell)	

Note: The conductors have a black, protective coating that you must remove with isopropyl alcohol to see their actual color.

MTQG Connector Assembly

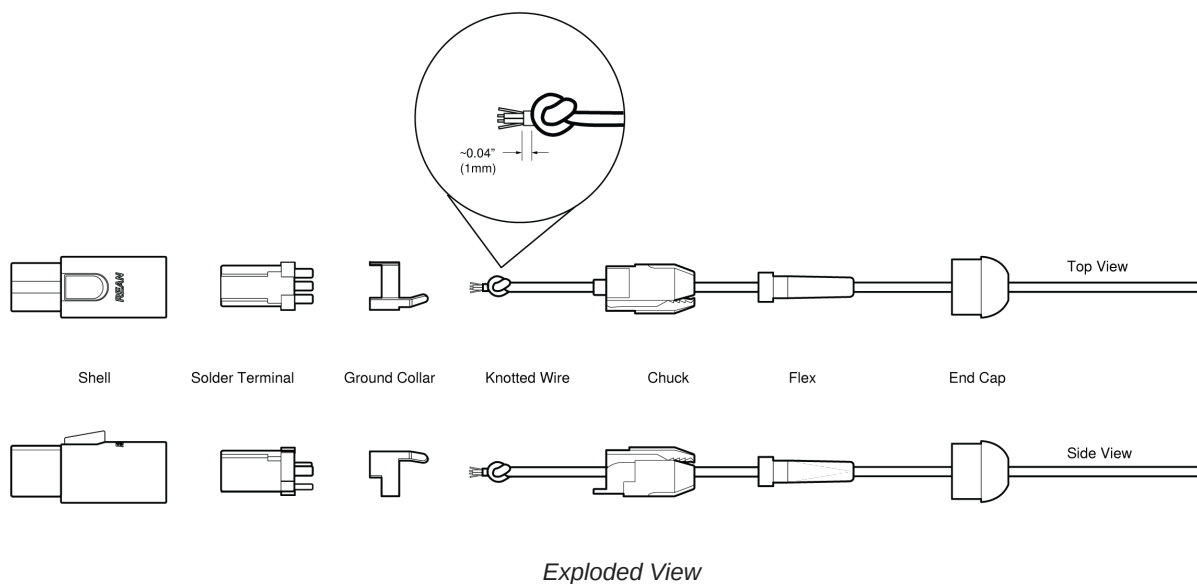

Note: Make sure to solder the shield to ground collar.

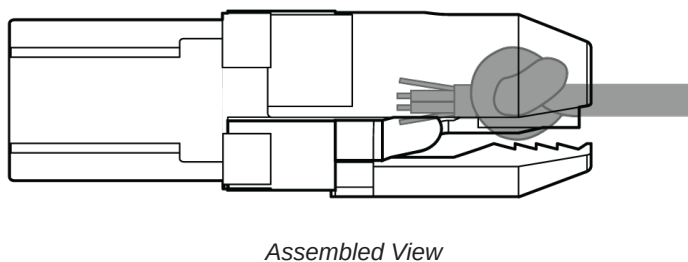

Specifications

Note:

- All specification values are based on using a typical bodypack with 5 V bias input or the RPM400MTQG preamplifier. When using the RPM400LEMO amplifier, refer to the RPM400LEMO specifications.
- All specifications measured with a 48 Vdc phantom power supply. The microphone operates at lower voltages, but with slightly decreased headroom and sensitivity.

Microphone Capsule

MEMS

Polar Pattern

Omnidirectional

Frequency Response

20 Hz to 20 kHz

Sensitivity

-42.5 dBV at 1 kHz ^[1]

Self-Noise, A-Weighted, Equivalent Acoustical

31 dB SPL-A

Signal-To-Noise Ratio ^[2]

63.0 dB

Maximum SPL ^[3]

132.0 dB SPL, 1 kHz at 1% THD, typical

Dynamic Range

101.0 dB typical

Microphone Current Draw

220 μ A, maximum

Bias Voltage

Recommended Operating Voltage

5 V DC, 2.6 V DC minimum

Housing

Molded ABS

Polarity

MTQG	Positive pressure on diaphragm produces positive voltage on pin 3 with respect to pin 1
-------------	---

LEMO	Positive pressure on diaphragm produces positive voltage on pin 3 with respect to pin 1
-------------	---

Cable Diameter
1.6 mm

Cable Length
66 in. (1.67 m)

Net Weight

DL4	15.0 g(0.53 oz.)
DH5	20.0 g(0.7 oz.)

^[1]1 Pa=94 dB SPL^[2]

S/N ratio is the difference between 94 dB SPL and equivalent SPL of self noise, A-weighted

^[3]

THD of microphone preamplifier when applied input signal level is equivalent to cartridge output at specified SPL

Dimensions

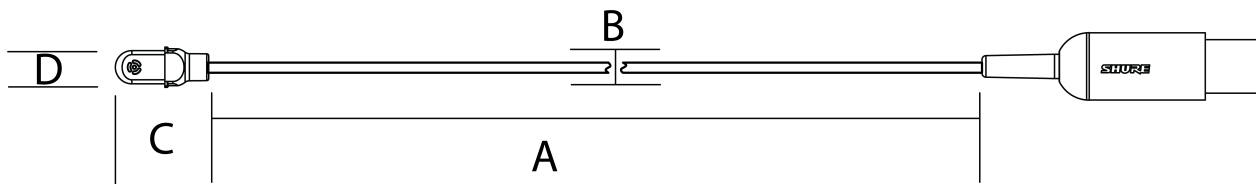

	A	B	C	D
	Cable Length	Cable Diameter	Microphone Length	Microphone Diameter
DL4	66 in. (1.67M)	1.6MM	14.5MM	5.2MM

Frequency Response

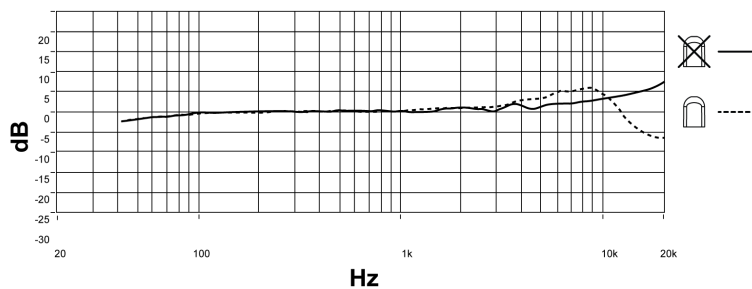

Certifications

Note: Testing is based on the use of supplied and recommended cable types. The use of other than shielded (screened) cable types may degrade EMC performance.

The CE Declaration of Conformity can be obtained from: www.shure.com/europe/compliance

Authorized European representative:

Shure Europe GmbH

Headquarters Europe, Middle East & Africa

Department: EMEA Approval

Jakob-Dieffenbacher-Str. 12

75031 Eppingen, Germany

Phone: +49-7262-92 49 0

Fax: +49-7262-92 49 11 4

Email: info@shure.de