

StudioLive™ Series III

Digital Mix Console / Recorder with Motorized Faders

Owner's Manual



Table of Contents

1 Overview — 1

- 1.1 Introduction — 1
- 1.2 About this Manual — 1
- 1.3 Feature Summary — 2
- 1.4 What's in the Box — 3

2 Getting Started — 4

- 2.1 Level Setting Procedure — 4
- 2.2 Useful Concepts — 8
 - 2.2.1 Select Buttons and the Fat Channel — 8
 - 2.2.2 FlexMixes — 9
 - 2.2.3 Fader Layers — 9
 - 2.2.4 DCA Groups — 9
 - 2.2.4 Recording and Playback — 9

3 Hookup — 10

- 3.1 Rear Panel Connections — 10
- 3.2 Top Panel Connections — 13
- 3.3 Typical Band Setup Diagrams — 14
- 3.4 Typical Church Setup Diagrams — 15

4 Basic Mixing and Routing — 16

- 4.1 Channel Strip Basics — 16
- 4.2 Fader Layers and Banks — 17
- 4.3 User Fader Layer — 18
- 4.4 Filter DCA Groups — 19
 - 4.4.1 Creating Filter DCAs — 19
 - 4.4.2 Editing or Deleting a Filter DCA Group — 20
 - 4.4.3 Managing DCA Group Masters — 20
- 4.5 Main Meters — 20
- 4.6 FlexMixes — 20
 - 4.6.1 Aux Mixes — 21
 - 4.6.2 Subgroups — 25
 - 4.6.3 Matrix Mixes — 28

- 4.7 FX Buses — 29
 - 4.7.1 Creating Internal Bus FX Mixes — 29
- 4.8 Fixed Subgroups — 30
- 4.9 Talkback System — 30
 - 4.9.1 Talkback Edit Screen — 31

5 The Fat Channel — 32

- 5.1 Fat Channel Navigation — 33
 - 5.1.1 Input Mode — 34
 - 5.1.2 Gate Mode — 37
 - 5.1.3 Compressor Mode — 40
 - 5.1.4 EQ Mode — 45
 - 5.1.5 Aux Sends Mode — 50
 - 5.1.6 User Mode — 51
- 5.2 Fat Channel Meters — 52
- 5.3 Input Source Selection — 52
- 5.4 Mic/Line Channel Buttons — 52
- 5.5 Output Assignment Buttons — 53
- 5.6 A/B Comparison for EQ and Dynamics Settings — 54
- 5.7 Stereo Link — 54
- 5.8 Copy/Paste & Preset Load/Save — 55

6 Tape Controls — 57

- 6.1 Pairing a Bluetooth Device — 57

7 SD Recording — 58

- 7.1 Creating a New Session for Recording — 58
- 7.2 Loading a Session for Playback — 59
- 7.3 Capture Screen — 60
 - 7.3.1 Recording Status Messages — 61
 - 7.3.2 Transport Controls — 61
- 7.4 Sound Check Button — 62

8 Master Control — 63

- 8.1 Home Button Features — 63
 - 8.1.1 System Screen — 64

- 8.1.2 Global Lockout — 68
- 8.1.3 Utilities — 69
- 8.1.4 Audio Routing — 69
- 8.2 FX — 71
 - 8.2.1 Digital XL Reverb — 71
 - 8.2.2 335 Digital Reverb — 72
 - 8.2.3 PAE-16 Digital Reverb — 72
 - 8.2.4 Vintage Plate Reverb — 73
 - 8.2.5 Mono Delay — 73
 - 8.2.6 Stereo Delay — 74
 - 8.2.7 Pingpong Delay — 74
- 8.3 UCNET — 75
 - 8.3.1 IP Address Settings — 75
 - 8.3.2 Permissions — 75
- 8.4 DAW Button — 75
- 8.5 Scenes — 76
 - 8.5.1 S1: Zero Out (Board Reset) — 76
 - 8.5.2 Nulling Parameters — 77
 - 8.5.3 Creating and Recalling a Scene — 78

9 Monitoring Controls — 80

- 9.1 Solo Controls — 80
 - 9.1.1 Solo Modes — 81
 - 9.1.2 Using the Solo Bus for Monitoring — 82
 - 9.1.3 Using Solo in Place to Set Up a Mix — 83

10 Graphic EQ — 85

- 10.1 Assigning GEQs — 86
- 10.2 Using the GEQ — 86
- 10.3 GEQ Presets — 87
- 10.4 Using the RTA to Ring Out Monitors — 87

11 Resources — 89

- 11.1 Networking Overview — 89
 - 11.1.1 Wired Ethernet Control Setup — 90
- 11.2 Stereo Microphone Placement — 91
- 11.3 Compression Setting Suggestions — 94

- 11.4 EQ Frequency Guides — 96
- 11.5 EQ Setting Suggestions — 97
- 11.6 Using Input Delay — 99
 - 11.6.1 Aligning the Backline with Vocal Mic — 100
 - 11.6.2 Aligning Direct and Mic'd Signals — 101
- 11.7 Using Output Delay — 101
 - 11.7.1 Front-of-House — 102
 - 11.7.2 Delay Systems — 102
 - 11.7.3 Aligning Subs to Mains — 104
- 11.8 Effect Types — 104
 - 11.8.1 Reverb and its Parameters — 104
 - 11.8.2 Delay and its Parameters — 105
 - 11.8.3 Chorus and Flange — 106
- 11.9 Technical Specifications — 107
- 11.10 Block Diagrams — 108

12 Troubleshooting and Warranty — 109

- 12.1 Troubleshooting — 109

13 Warranty Information — 110

- 13.1 How Consumer Law Relates To This Warranty — 110
- 13.2 PreSonus Products And EU Statutory Warranty — 110
- 13.3 What This Warranty Covers — 110
- 13.4 Exclusions and Limitations — 110
- 13.5 Who This Warranty Protects — 111
- 13.6 How Long This Warranty Lasts — 111
- 13.7 What PreSonus Will Do — 111
- 13.8 How to Get Warranty Service (USA) — 111
- 13.9 How to Get Warranty Service (outside of USA) — 111
- 13.10 Limitation of Implied Warranties — 111
- 13.11 Exclusion of Damages — 112

1 Overview

1.1 Introduction



Thank you for purchasing your PreSonus® StudioLive™ Series III Digital Mixer. PreSonus Audio Electronics has built your StudioLive mixer with high-grade components to ensure optimum performance for many years to come. Loaded with 32, 24, or 16 high-headroom XMAX™ microphone preamplifiers, a built-in 38x38 USB recording and playback interface, powerful Fat Channel signal processing, high-quality effects, extensive routing and submixing, talkback, and more, StudioLive Series III breaks new boundaries for music performance and production. All you need is a compatible computer with a USB connection or an SD card, a few microphones and cables, speakers, and your instruments, and you are ready to record in the studio or in front of a live audience!

We encourage you to contact us with questions or comments regarding this product. PreSonus Audio Electronics is committed to constant product improvement, and we value your suggestions highly. We believe the best way to achieve our goal of constant product improvement is by listening to the real experts: our valued customers. We appreciate the support you have shown us through the purchase of this product.

1.2 About this Manual

We suggest that you spend some time with this manual before starting to work with your StudioLive Series III mixer, to familiarize yourself with its features, workflows, and connection procedures. This will help your setup process go as smoothly as possible. This manual applies to all StudioLive Series III mixers. While all three StudioLive Series III mixers provide exactly the same mixing capabilities internally, their input and output configuration differs. Where these differences occur, the StudioLive 32 will be listed first, followed by the StudioLive 24, and then the StudioLive 16.

A separate manual, contains information about the StudioLive Series III Software Library, as well as instructions for connecting and using your StudioLive Series III mixer with a computer.

Throughout this manual, you will find Power User Tips, providing mixing tricks (some of which are uniquely suited to the StudioLive Series III), and explanations of various useful audio terms. Near the end of this manual, you'll find a selection of audio tutorials, covering everything from microphone placement to recommended equalizer and compression settings. We hope these tutorials help you to get the most from your StudioLive Series III mixer.

Thank you, once again, for purchasing our product. We are confident that you will enjoy your new StudioLive.

1.3 Feature Summary

General Controls

- 33/25/17 touch-sensitive, motorized faders
- RGB Select buttons with user-assignable colors
- Transport control
- All-new Fat Channel controls including:
 - 8 scribble strips, encoders, and multicolor buttons
 - Customizable user layer
 - 7-inch color touchscreen

Inputs and Outputs

- 40/32/22 total inputs
- 16/10 FlexMix outputs
- Bluetooth™ 4.1 wireless tape input
- Stereo AES/EBU digital output
- 2 XLR (L/R) Main outputs
- XLR Main summed mono output
- 2 TRS monitor outputs
- Stereo headphone output

Channels and Buses

- 32/24/16 input channels with recallable XMAX Class A mic preamps
- 2 stereo aux inputs
- 16 FlexMixes, 4 fixed Subgroups
- 4 internal effects sends
- Stereo main bus
- 24 Filter DCAs for flexible control of multiple channels

Recording

- Onboard 34x34 SD recorder
- 38x38 USB recording interface
- 55x55 AVB recording interface

Digital

- Studio-quality converters with 115 dB dynamic range
- 48 kHz operation with 24-bit resolution
- UC Surface touch control software for macOS®, Windows®, and iPad®
- Studio One® Pro digital audio workstation and mastering software for macOS and Windows (StudioLive 32)
- Studio One® Artist digital audio workstation software for macOS and Windows (StudioLive 24 and 16)
- Capture™ multitrack recording software for macOS and Windows
- QMix®-UC aux-control software for iOS® and Android™ available free from Apple App Store, Google Play, and Amazon App Store

1.4 What's in the Box

In addition to a Visual Quick Start Guide, your StudioLive package contains the following:



- PreSonus StudioLive Series III digital recording and performance mixer
- 1 meter USB cable

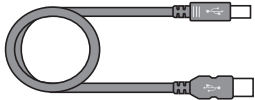

- 1 meter CAT6 Ethernet cable

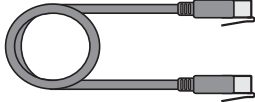

- StudioLive Series III Quick Start Guide

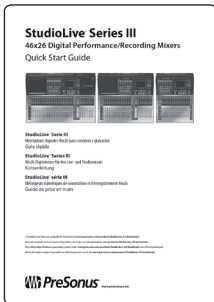

- IEC power cord

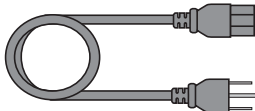

Power User Tip: All companion software and drivers for your PreSonus StudioLive Series III mixer are available for download from your My PreSonus user account. Please visit <http://my.presonus.com> and register your StudioLive Series III mixer to receive downloads and licenses.

2 Getting Started

Before you begin, here are a few rules to get you started:

- Always turn down the Main fader and both the Monitor and Phones knobs in the Monitor section before making connections.
- Before plugging or unplugging a microphone while other channels are active, mute the channel to which you are connecting.
- Your faders should be set on or near the “U” mark whenever possible. The “U” indicates unity gain, meaning the signal is neither boosted nor attenuated. If the main output of your StudioLive is too high or too low when your faders are at or near unity, you can use the output-level knob on the rear panel of the StudioLive to adjust the level up or down until you have achieved the optimal volume.
- Do not allow your inputs to clip. Watch the level meters; when signal nears Clipping, the top LED illuminates, indicating that the analog-to-digital converters are in danger of being overdriven. Overdriving the converters will cause digital distortion, which has a negative effect on sound quality.

Your P.A. and studio equipment should be powered on in the following order:

- Sound sources (keyboards, direct boxes, microphones, etc.) connected to the StudioLive inputs
- StudioLive Series III mixer
- Computer (if applicable)
- Power amplifiers or powered loudspeakers

When it is time to power down, your system should be turned off in the reverse order. Now that you know what not to do, let's get started!

2.1 Level Setting Procedure



1. Plug a microphone into the Channel 1 input on your StudioLive Series III with a standard XLR cable.

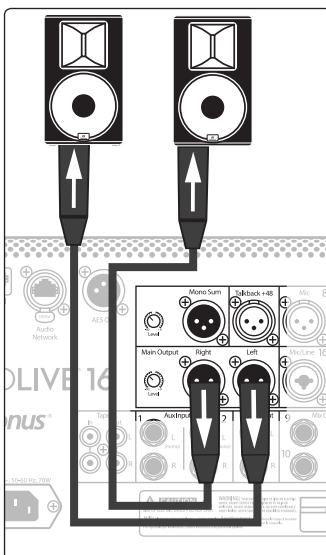

2. Connect the main outputs of your StudioLive to your powered monitors (or power amp if using passive speakers).

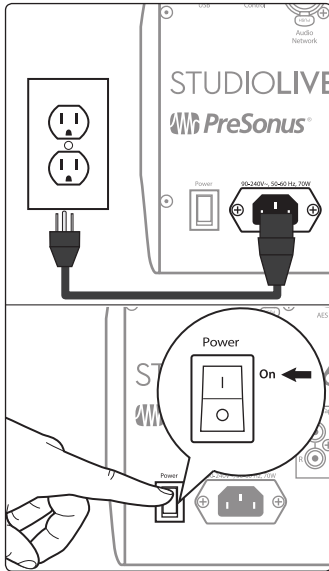

3. Plug your StudioLive into a power outlet and turn it on.

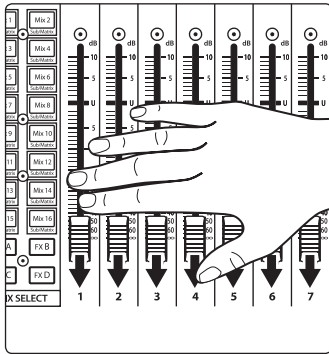

4. Move all of the faders on your StudioLive down to the lowest setting.

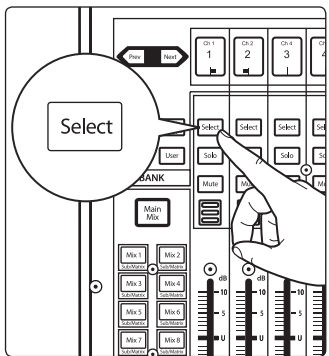

5. Press the Select button on Channel 1 to bring it into focus in the Fat Channel.

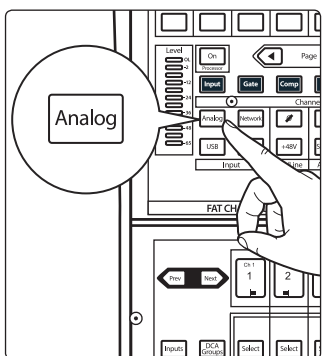

6. Press the Analog button in the Fat Channel to patch in the analog input.

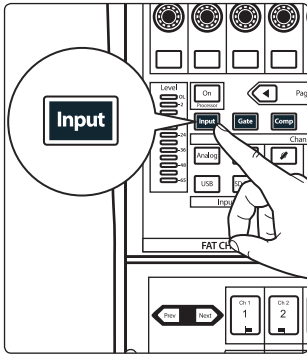

7. Press the Input button in the Fat Channel.

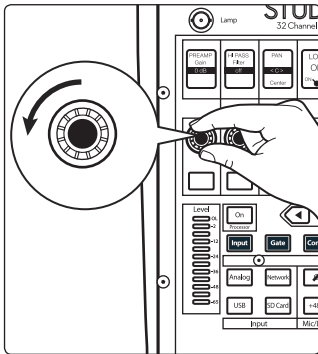

8. Turn the first knob in the Fat Channel section (Preamp Gain) counter-clockwise to its lowest setting.

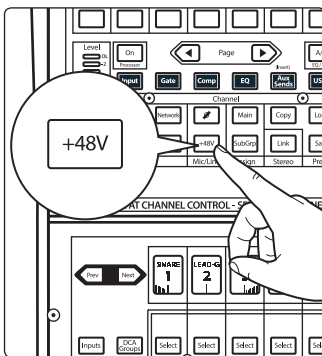

9. If your microphone requires phantom power, press the +48v button in the Fat Channel.



10. Turn on your powered monitors or power amp.
11. Speak or sing into your microphone at the same volume as the performance.

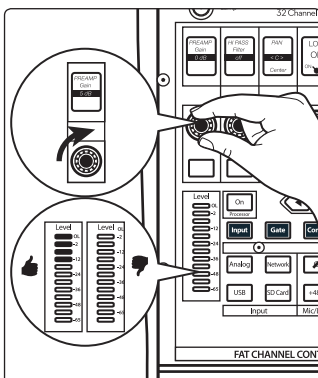

12. Turn the first knob in the Fat Channel section (Preamp Gain) clockwise while watching the Level (input) meter in the Fat Channel. Adjust the Preamp Gain knob until the meter shows an average level around the middle of its range. Avoid lighting the red (clip) LED at the top of the meter.

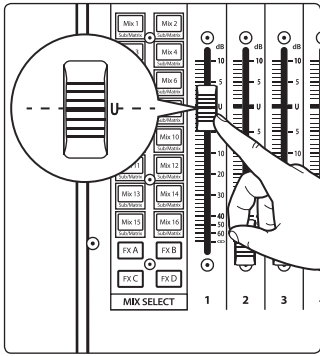

13. Raise the Channel 1 fader to its “U” setting (unity gain).

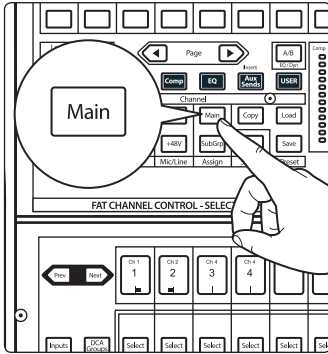

14. Press the “Main” button in the Fat Channel to assign Channel 1 to the Main output bus.

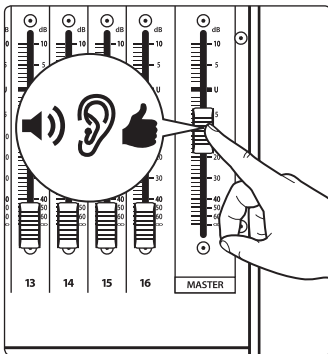

15. Raise the Main fader while singing or speaking into the microphone until you are satisfied with output level.

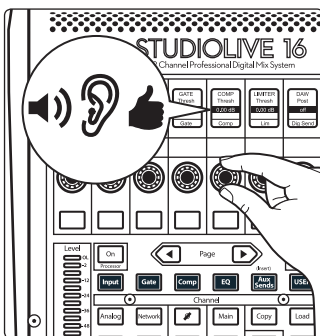

16. Use the Fat Channel controls to add dynamics processing and EQ as needed.

2.2 Useful Concepts

This section covers some basic workflow concepts to help you to more quickly get acquainted with your StudioLive.

2.2.1 Select Buttons and the Fat Channel



All around the StudioLive, you will see Select buttons. There is a Select button on each channel as well as the master fader. Each of these buttons serves exactly the same purpose: to access the available Fat Channel parameters for its channel or bus. These buttons will also change colors to alert you as to the type of mix you are viewing (Aux, Subgroup, or Matrix)



The Fat Channel is the heart of the StudioLive. It gives you a wealth of powerful signal processing, mixing, and configuration tools to help you make the most of your mixer. Each channel and mix in your StudioLive can take advantage of the Fat Channel functions at the touch of the corresponding **Select** button.

The 8 multipurpose knobs, buttons, and Scribble Strip displays in the Fat Channel shift their functions to suit your needs as you move between tasks. The integrated touchscreen works in tandem, providing useful information and fluid touch control.

For more information on using the Fat Channel system, *see Section 5*.

2.2.2 FlexMixes

In a traditional analog console, there are several different types of buses, each feeding a dedicated output. Your StudioLive mixer features 16/10 analog Mix outputs, each driven by a FlexMix bus. Why do we call them FlexMixes? Because each FlexMix can be configured as any one of four bus types:

- **Pre- or Post-Fader Send Aux Bus.** Aux buses provide auxiliary mixes that are separate from the main and subgroup mixes.
- **Subgroup.** Subgroups are alternate buses that act much like the Main L+R bus on your StudioLive.
- **Matrix Mix.** Matrix mixes provide auxiliary mixes created from any bus output as well as every input channel.

What's more, FlexMixes can be stereo linked or used as mono, providing maximum flexibility.

Note: Like the StudioLive 32 and StudioLive 24, the StudioLive 16 provides 16 Flex Mixes. The last six of which can be routed to an AVB network.

For more information on using and configuring FlexMixes, *see Section 4.6*

2.2.3 Fader Layers

To provide the most compact form factor, the StudioLive mixer utilizes fader layers. Each layer allows you to view the channel strip controls for the input channels in each mix. Additional fader layers allow you to view just the Aux Inputs, the DCA Group outputs, or the Mix Master outputs.

More information about Fader Layers can be found in *Section 4.2 and 4.3*.

2.2.4 DCA Groups

Filter DCA Groups are a way to control the overall volume of a group of related channels (such as all drum channels). While you can accomplish a similar result by routing channels to a subgroup and controlling their volume with the subgroup master, DCA Filter Groups require no such re-routing and offer some additional utility.

For more information on using DCA Filter Groups, *see Section 4.4*.

2.2.4 Recording and Playback

The StudioLive Series III mixers are equipped with a multi-track SD recorder that allows you to record all input channels plus the main bus. This SD recorder is completely integrated with your mixer and is designed to simplify recording and playback. Playback channels from the SD card can be switched individually per channel.

In addition to the onboard SD recorder, a USB audio interface is also included. This interface is continuously bidirectional, allowing you to use plugins as inserts as well as recording and playback applications.

More information about SD recording and playback is available in *Section 7*.

More information on USB recording and playback is available in the *StudioLive Software Library Reference Manual*.

3 Hookup

3.1 Rear Panel Connections

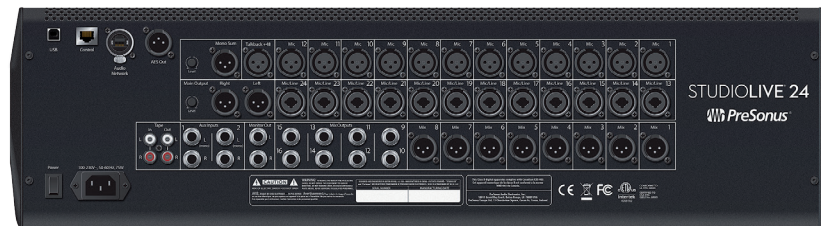

Microphone Inputs. Your StudioLive Series III mixer is supplied with 32/24/16 PreSonus XMAX microphone preamplifiers, for use with all types of microphones. The XMAX preamp features a Class A input buffer circuit, followed by a dual-servo gain stage. This results in exceptionally low noise, and a wide range of gain, allowing you to boost signals significantly without introducing unwanted background noise.



48-volt Phantom Power. The StudioLive provides individually-switchable 48V phantom power for each microphone input.

WARNING: Phantom power is required for condenser microphones and certain other specialty microphones that contain active preamp circuitry. However, applying phantom power to mics that don't require power can damage them (especially ribbon mics). Switch phantom power off for all channels where it is not required.

XLR connector wiring for phantom power:
Pin 1 = GND Pin 2 = +48V Pin 3 = +48V



Mic/Line Inputs. Half of the microphone inputs on your StudioLive can also accept line-level signals. These inputs use TRS-XLR combo jacks that can accept both XLR and balanced or unbalanced 1/4" cables. The 1/4-inch TRS connectors bypass the gain stage and are scaled to accept line-level signals up to +18 dBFS.

Power User Tip: When the line inputs are engaged, the microphone preamp circuit is bypassed completely, and no trim control is available. Typical examples of line-level connections are synthesizer outputs, signal processors, and stand-alone mic preamps and channel strips. Use the output level control on your line-level device to adjust its level.

Note: As with many audio devices, plugging a microphone or line-level device, or enabling/disabling phantom power can create a momentary noise spike in the audio output of your StudioLive mixer. It is highly recommended that you mute or turn down a channel's fader before changing connections or toggling phantom power on or off.

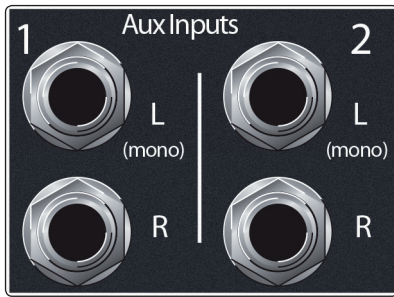

Aux Inputs. The StudioLive offers two balanced stereo auxiliary inputs. While these line inputs are generally used as effects returns, they can also be used for any line-level source (synthesizers, amp modelers, etc.). The left input of each pair is normalled to the right input, so if you are returning a mono signal to the mix, connect it to the left input, and the signal will be routed to both sides of the mix.

Power User Tip: More information about using external effects processors can be found in [Section 4.6.1.2](#).



Sub Outputs (StudioLive 32 only). These are balanced mono outputs, one for each subgroup.

Power User Tip: While the StudioLive 24 and 16 do not provide dedicated outputs, it does provide four subgroups that can be routed to the AVB network.

More information about Subgroups can be found in [Section 4.6.2](#).



Mix Outputs. Your StudioLive features 16/16/10 Mix Outputs. Given the flexible nature of these mix buses, the Mix Outputs may be used to output Aux, Subgroup, or Matrix mixes. Your StudioLive is equipped with 12/8/6 XLR Mix Outputs and 4/8/4 balanced ¼"TRS Mix Outputs.

Power User Tip: More information about configuring mixes can be found in [Section 4.6](#).



Talkback Mic Input. The StudioLive does not have a built-in talkback microphone, so an external mic must be used. Phantom power is always enabled on the Talkback Mic input, so either a dynamic or condenser mic can be used. However, if using a dynamic mic, we recommend checking its documentation to verify that phantom power will not harm it.

Power User Tip: The Talkback Mic input uses the same high-quality XMAX mic preamp employed by the other input channels, and can be enabled as a recording input.



Main Outputs. The StudioLive features both stereo and mono-summed main outputs, on XLR jacks. A level control is provided for both sets of outputs. The Main (stereo) output level control has a range of -80 to 0 dB. The Mono Sum output level control has a range of -80 to +6 dB.

Power User Tip: Both the stereo and mono-summed Main outputs are active at all times.



Tape In/Out. These RCA input and output jacks can be used to connect a music player (MP3, CD, tape) or other consumer device to your system. The Tape inputs are an available input source within the mixer, while the Tape outputs mirror the output of the Main output pair.



Monitor Outputs. This pair of balanced TRS outputs are intended to be connected to a pair of monitors in the control room or sound booth. The level is controlled by the Monitor knob in the Monitors section on the top panel.

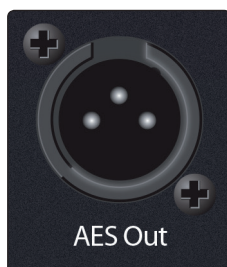

AES Output. By default, the AES/EBU digital output receives the same signal as the stereo Main outputs. However, you can route any of the mix buses, Tape input, or the Solo bus to this output. Because the StudioLive cannot be synced externally, you will need to use it as the master clock and set your AES-equipped device to receive word clock externally via AES. Please consult the documentation for your external digital device for instructions.

Power User Tip: This output can also be connected to S/PDIF-format devices, through the use of an AES/EBU-S/PDIF adapter. A standard XLR-RCA adapter will not function. AES/EBU-S/PDIF adapters contain impedance-matching circuitry that is required for proper function.

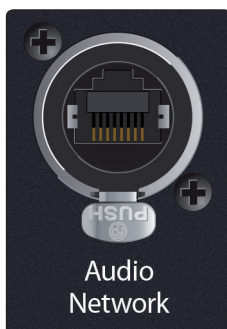

Audio Network. This connection accepts both Ethercon and RJ-45 connections and is used for AVB audio networking.

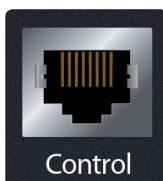

Ethernet Port. This RJ-45 port is used to connect your StudioLive to a standard LAN network for control applications only.

Power User Tip: More information about AVB and control networking can be found in Section 11.1.



USB Port. This female USB-B jack provides connection to a computer for audio interfacing, control, and file transfer duties.



Power Input. Connect the provided IEC power cable to this input.



Power Switch. Push the top part of this switch to power your StudioLive on, and the bottom to switch power off.

3.2 Top Panel Connections

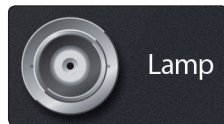

Lamp Connector. This 12V BNC connection is provided to connect a third-party console lamp. Do not use a bulb that is larger than 12V, 380 mA.



SD Card Slot. This slot accepts standard-sized SD cards at capacities up to 32 GB (SDHC supported). SD cards can be used for audio recording and playback, storage and recall of mixer settings, and firmware updates.



Headphone Output. On the front of the StudioLive, a 1/4-inch TRS jack is available for connecting a pair of headphones. Headphone output level is set by turning the Phones knob in the Monitors section of the mixer. By default, this output receives its signal from the solo bus, but you can freely assign any mix bus (pre-or-post-fader), USB Digital Return, or audio network input to the Headphone output. *See Section 9* for more information.

3.3 Typical Band Setup Diagrams

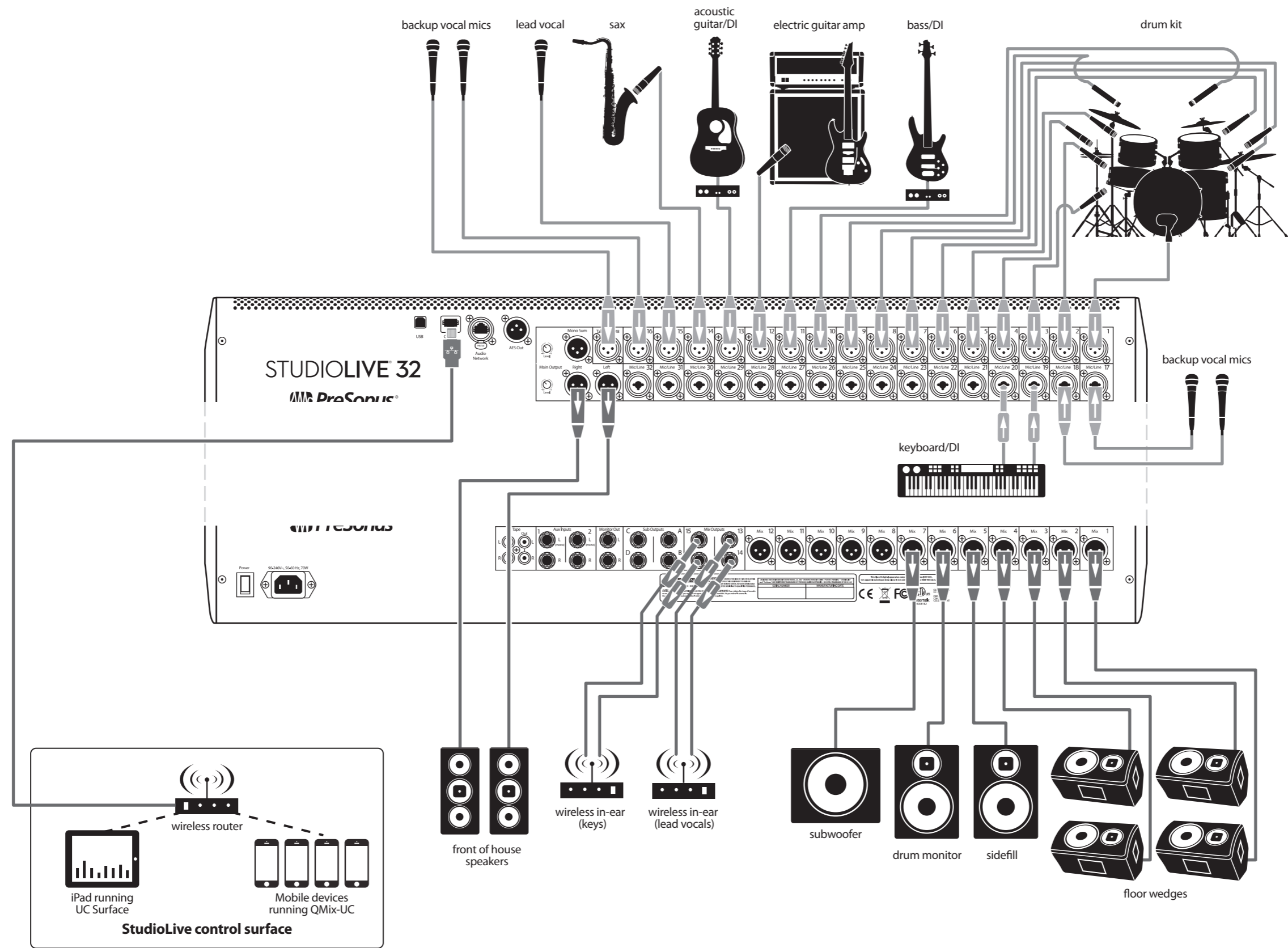

3.4 Typical Church Setup Diagrams

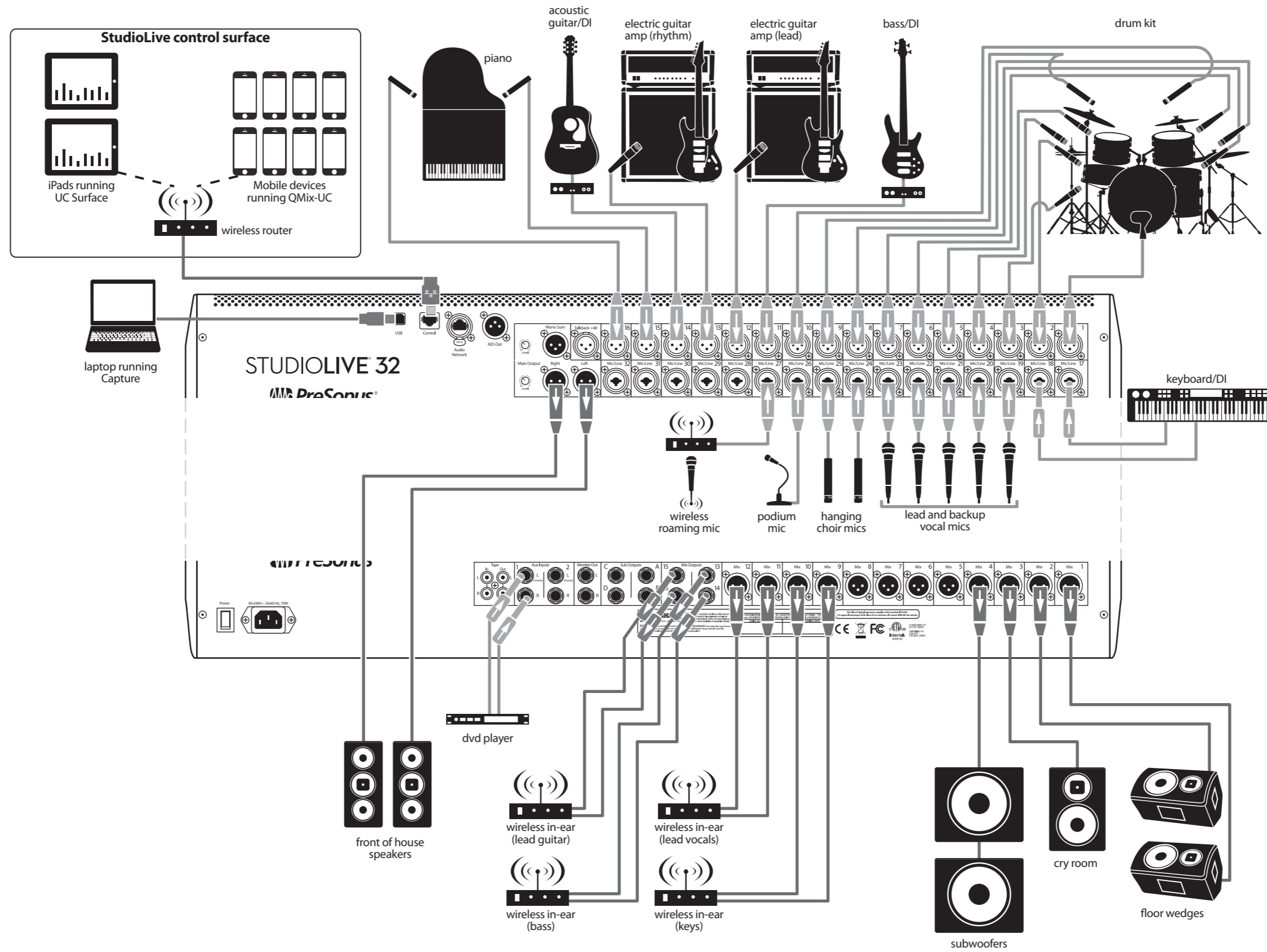

4 Basic Mixing and Routing



StudioLive Series III mixers offer many powerful and flexible mixing tools that allow you to quickly set up and monitor multiple mixes at once and have been designed to make managing multiple layers of input channels, mix masters, and fader mixes, as well as navigating even the most complicated systems simple.

4.1 Channel Strip Basics

If you've used a mixer before, the StudioLive channel strip layout may look familiar. Each channel strip on your StudioLive (apart from the Master) features the following controls and visual aids:

Scribble Strip Display



This graphical display shows you useful information about the input channel or mix master that the channel is currently addressing. The following details are displayed:

- **Name.** Shows the name for the currently displayed channel.
- **Number.** Shows the number and type of the currently displayed channel. Standard inputs are numbered normally. Aux input channels begin with "A," Tape inputs with "Tape," FX returns with "FX," Aux Bus Masters with "Ax," Subgroup Masters with "Sb," and Matrix Masters with "Mx."
- **Pan Position.** Shows the current pan position for the currently displayed channel.

Select Button



Press this button to select the current channel or bus. Generally, this function is used to bring the Fat Channel into focus for the selected input, mix, or bus.

Solo Button



This button will solo its channel to the main outputs or to the monitor outputs, depending on whether AFL/PFL (Pre-Fader Listening) or SIP (Solo In Place) is selected in the Solo Edit Menu. *Please review Section 9.1* for details.

Mute Button



Press this button to mute the corresponding channel, mix, or bus. Press it again to unmute.



Level Meter

Each channel has a three-segment LED level meter, which gives a quick indication of signal levels flowing through that input, mix, or bus. The bottom segment begins to light when the signal reaches -40 dBFS. The middle segment begins to light when the signal reaches -18 dBFS. The top LED, which is red to remind you that clipping is near or already occurring, begins to light when the signal reaches -1.5 dBFS. It lights most strongly once the signal reaches -0.2 dBFS (trouble ahead!)



Channel Fader

This touch-sensitive motorized fader lets you control output volume for the input, mix, or bus that the channel is currently addressing. When the fader is pulled all the way down (to the ∞ mark), the signal is muted entirely. At the "U" mark (for unity gain), the mixer is neither boosting nor attenuating the signal. Settings above "U" add up to 10 dB of gain.

Power User Tip: Because the channel faders are motorized, you can quickly flip between mixes and recall mix scenes with needing to manually recall them.

4.2 Fader Layers and Banks

With so many available analog and digital inputs, mixes, buses, and DCAs, your StudioLive has more internal mix elements than it does channel strips to control them. This is where fader layers come in.

You can switch between these layers using the following buttons:



Inputs. This displays the input channels across all faders so that the channel strips control corresponding Mic and Mic/Line input channels.



User. The User layer allows you create a custom selection of channels for quicker access. For more information on the User layer, *see Section 4.3.*



Aux Inputs (StudioLive 32 and 24 only). While active, the eight channel strips to the right of the Master fader control FX Returns A-D, Aux Input 1 & 2, Tape Input, and Talkback. Channel strips 1-24/16 continue to address input channels 1-24/16 as normal.



DCA Groups. Channel strips control the master faders of the Filter DCA Groups. Press Prev and Next buttons to reach all 24 DCA Groups.



Mix/FX Masters. Channel strips control the master faders and mute/solo states for available Subgroups, FlexMixes, and FX buses.



Press the **Prev** and **Next** buttons to scroll through the other available input channels and output buses.

4.3 User Fader Layer

The User layer lets you choose a hand-picked selection of channels that are visible when you press the **User** button. This can be useful to access crucial channels quickly, especially in mixes with high channel counts.

To assign channels to the User layer, do the following.

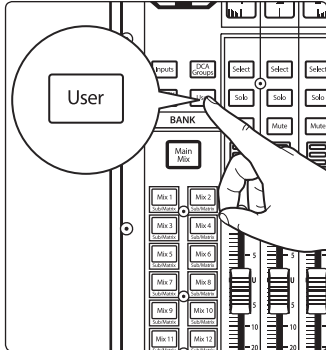

1. Navigate to the User layer by pressing the **User** button.

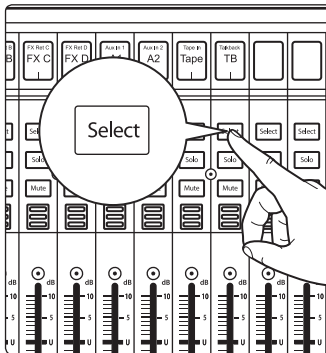

2. Press **Select** on a channel strip to which you wish to assign a mixer channel or any unused channel in the user layer.

3. The User Layer Assignment screen will be displayed on the touchscreen.

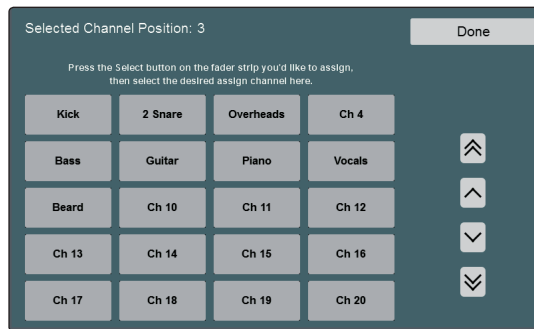

4. Select the channel of your choice on the touchscreen to assign it to the channel strip of your choice.
5. Repeat steps 2-4 as necessary to populate the User layer with your most needed channels.
6. Press **Done** when finished.

To Edit the User layer, press and hold the **Select** button for the channel whose assignment you'd like to change. This will open the User Layer Assignment screen. From here you can unassign the channel completely or change the channel assigned to it. Every channel, mix master, and DCA group master is available to assign to the User Layer.

4.4 Filter DCA Groups

Professional mixing consoles have addressed the problem of managing complex mixes with population groups that reduce the channels you're viewing at one time and DCAs that control the overall level of a group of channels.

We've combined the best aspects of these solutions with Filter DCAs. A Filter DCA can contain any combination of the available input channels and effects returns, and you can create as many Filter DCA groups as you need. You can even include the same channel in multiple Filter DCAs so you can manage mixes in multiple ways. Each group is given a master level control so you can control the overall level of the group while maintaining each channel's relative balance in the mix. In this way, for example, you can create a single fader to control every drum in a monitor mix and maintain the relative level of the drum mix that you created.

Once selected, a Filter DCA group stays active until exited regardless of which mix is selected. This allows you to adjust the group independently across different mixes. You can also flip between groups on the fly to change the view of a selected mix.

You can create up to 24 Filter DCA Groups.

4.4.1 Creating Filter DCAs



1. To create a new Filter DCA Group, press the **DCA Groups** button in the Master Control section.
2. This will open the Filter DCA Group edit screen.



3. Press the "+" button on the Master Control Touchscreen.
4. Press the default name to create custom filter name. Press "Enter" when done.
5. The **Select** buttons on your mixer will flash. Press the Select buttons for the channels you'd like to assign to your new Filter DCA Group. The Select buttons will illuminate solid as the channel is assigned to the group. You can also use the select buttons on the Touchscreen to assign channels.
6. Press "Done" when you've finished making your channel selections.

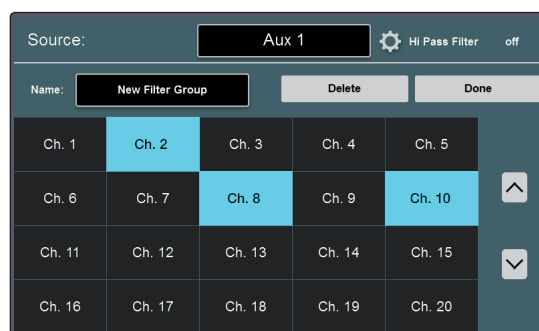

4.4.2 Editing or Deleting a Filter DCA Group

1. To edit or delete a Filter DCA Group, first touch its name to select it.
2. Touch the **Edit** button to enter the Filter DCA Group Edit screen.
3. To add or remove a channel from the group, touch the name of the channel in the provided list to select or deselect them. To name or rename the group, touch the name field. To delete this group, touch the **Delete** button.

When you're finished, touch Done to confirm your changes.

4.4.3 Managing DCA Group Masters



You can bring the master faders for all existing Filter DCA Groups to the channel strips by pressing the **DCA Groups** button in the Bank section.

Pressing the Select button on a DCA Group master while the DCA Groups screen is active will select it on the screen.

Power User Tip: Pressing the Select button for a DCA Group Master will spill the group on the faders. In this way, you can quickly make adjustments to a DCA mix.

4.5 Main Meters

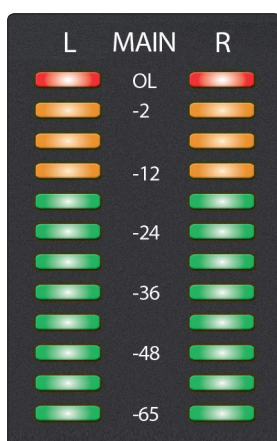

This meter shows signal level for the Main bus. The green LEDs at the bottom begin to light at -65 dBFS, continuing upward to -18 dBFS. The bottom-most yellow LED begins to light at -12 dBFS, continuing upward to -2 dBFS. The red LED at the top of the meter lights when the signal reaches -0.1 dBFS, and remains lit for 5 seconds, once activated, to better alert you that clipping is occurring.

4.6 FlexMixes



StudioLive Series III mixers provide 16 FlexMixes that can be used for a variety of applications:

- **Aux Mixes.** Sums Aux Send levels sent from input channels. Aux mixes can be used for many applications. The two most common applications are creating monitor mixes and inserting external effects processors into the mix.
- **Subgroup.** A subgroup allows you to combine multiple channels into a single bus so that the overall level for the entire group is controlled by a single fader and processed by the Fat Channel. Subgroups can be routed to main mix, to a dedicated output, or both.
- **Matrix.** A variant of the Aux, a Matrix can draw signal from inputs, other mixes, buses, the main output bus, and so on. Matrix mixes are more commonly used to send audio to different loudspeaker zones or to provide a producer or director a different mix.

The **Mix Select** buttons allow you to choose the mix you'd like to control. When a mix is selected, the channel faders will display the level for that mix only. These buttons will change color depending on how they are configured.

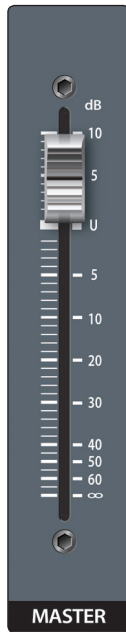

When a mix is selected, the **Master fader** will control its output level.



To view the master output level for every mix, press the Mix/FX Masters button.



To choose the type of FlexMix behavior to be used for the Aux (Aux, Subgroup, or Matrix), touch the gear-shaped button to open the FlexMix Settings screen and make your selection from the menu. Once you're done, exit the FlexMix Settings screen and create your mix.

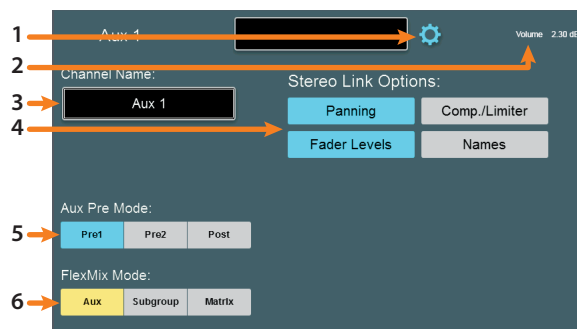

1. **Close Settings.** Tap to exit the Settings menu.
2. **Current Parameter.** Displays the currently selected parameter and its current value.
3. **Mix Name.** Tap to customize name.
4. **Stereo Link Options.** You can choose to link the four functions when creating a stereo bus, or leave them independently controllable: Fader Level, Compressor/Limiter, Names, and Bus Panning (Stereo Matrix Mixing only).
5. **Aux Pre Mode (Aux Mode only).** Sets the Channel Send position when a FlexMix is designated as an Aux Mix. *See Section 4.6.1* for details.
6. **FlexMix Mode.** Sets the functionality of the FlexMix: Aux, Subgroup, or Matrix.

4.6.1 Aux Mixes

As its name implies, an Aux mix allows you to create an alternate, or “auxiliary,” mix that can be routed to an output separate from the Mains. Aux buses have many applications, the two most common of which are creating monitor mixes and inserting external effects processors into the mix. When you turn up the aux send level on a channel, its signal is sent to the corresponding aux output at the level you choose. In this way, the same channel can be used to create several alternate mixes to the main mix.

To create an Aux Mix:

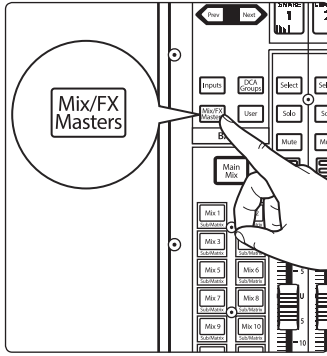

1. Press the **Mix/FX Master** button. This will bring up the FlexMix Masters onto the channel strips.

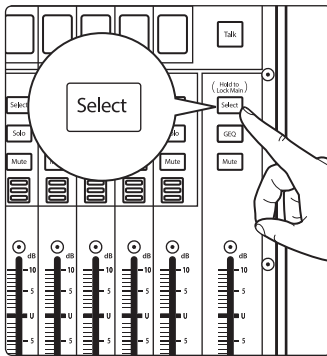

2. Press the **Select** button for the FlexMix Master you'd like to make an Aux Mix.



3. Press the **Settings** button on the Master Control Touchscreen.

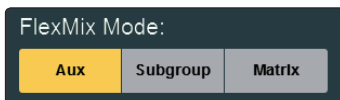

4. Press the **Aux** button under FlexMix Mode.

Pre/Post Channel Sends

You can select the send positions for the channels routed to each Aux mix. By default, all aux buses are set to Pre 1. This places the send of every input channel to each aux bus before the fader, limiter, EQ, and compressor, but after the Polarity Invert switch, high-pass filter, and gate.

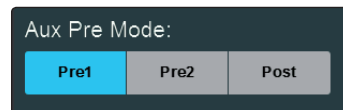

From the FlexMix settings menu, you can choose between three send positions for your mix:

Pre 1: Sends each channel to the Aux bus after the polarity invert, high-pass filter, and gate.

Pre 2: Sends each channel to the aux bus after all Fat Channel processing (polarity invert, high-pass filter, gate, compressor, EQ, and limiter) but before the fader.

Post: Sends each channel to the Aux bus after all Fat Channel processing (polarity invert, high-pass filter, gate, compressor, EQ, and limiter), and after the fader.

Power User Tip: Use the Pre 2 position for headphone and in-ear mixes to give your performers a polished "studio" sound. This setting should be avoided for floor wedges, as compression can cause feedback problems.

4.6.1.1 Creating Aux Mixes

Creating custom monitor mixes is critical. If musicians can't hear themselves or their bandmates, their performance will suffer. A monitor mix can be mono or stereo. Most often, an individual live monitor mix is mono and is sent to a floor-wedge or sidefill monitor (the obvious exception being in-ear monitor systems). A studio monitor mix is usually stereo because it is sent to a headphone amplifier that requires both a left and a right-channel input. In both cases, the function of the aux bus is the same.

As an example, let's create a mono monitor mix on FlexMix 1.

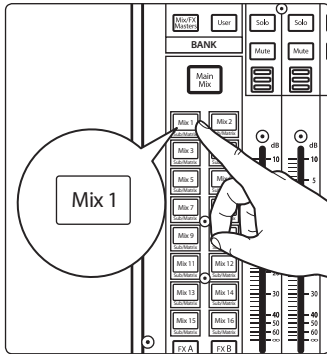

1. Press the **Mix 1** button in the Mix Select section to access settings for Aux mix 1. The faders move to show send levels to Aux 1 for each channel in your mix.
2. Ask the musician(s) what signals they would like to hear in their monitors, and use their requests as a starting point, adjusting the faders for the relevant channels to create a monitor mix.

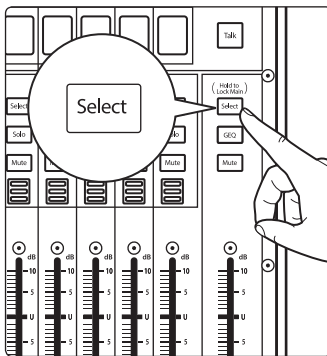

3. Press the **Flex Fader Select** button to access the Fat Channel processing for the monitor mix output. This can be useful for eliminating feedback in a monitor. EQ can also be used to increase the presence of an instrument by boosting that particular frequency range without necessarily boosting the send level in the mix. This is great for getting the lead guitar to cut through in the guitarist's monitor mix and to provide that extra rumble in the bassist's mix.

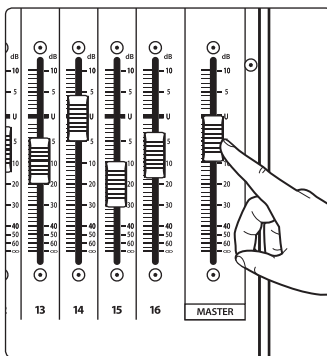

4. Move the **Master** fader to adjust the overall level of the monitor mix.

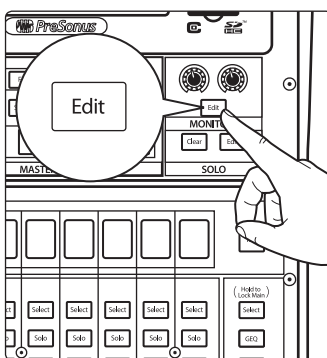

5. You can listen to the monitor mix you're creating in your headphones or control room monitors by pressing the **Edit** button in the Monitors control section.
6. Select **Monitor** or **Phones** on the touchscreen, then touch the Aux mix you're working on at the moment (Mix 1, in this example).

4.6.1.2 Working with External Effects Processors

Creating a mix to send to an external effects processor is similar to creating an internal FX mix, only in this case, we route the mix signal to a mix output (Mix Output 7, in this example), and route the effected signal from the processor back to a stereo Aux input (Aux Input 1, in this example) on the mixer. If your effects processor is mono, connect its output to the L (left) jack of the Aux Input.

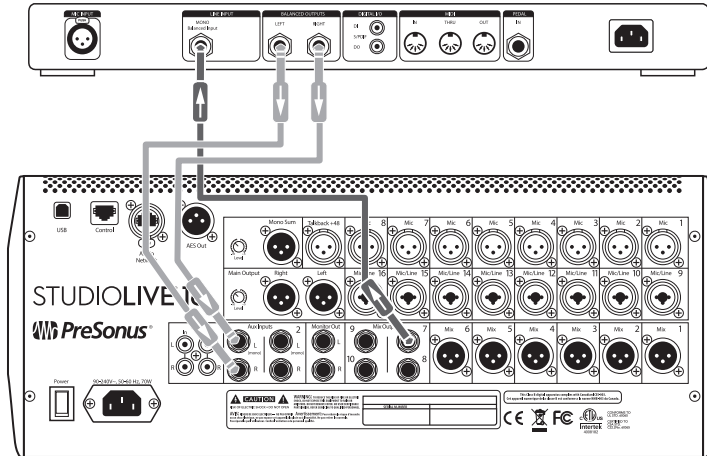

1. Connect Aux Output 7 to the input of your external effects processor, and connect the outputs of the processor to the Aux Input 1 jacks.
2. Press the **Main Mix** button.

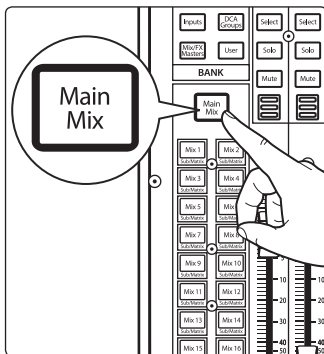

3. Press the **Next** button to bring the Aux Input channel layer.

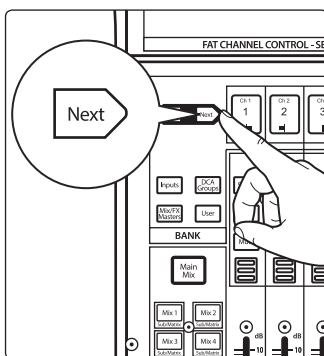

4. Press the **Select** button that corresponds to Aux Input 1 (the input pair you're using as an effects return), to access its settings in the Fat Channel.

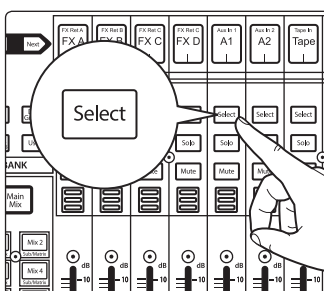

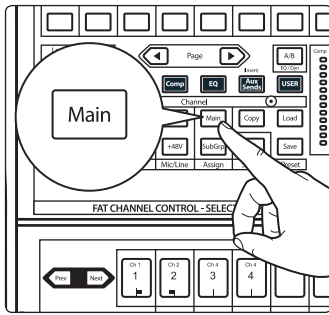

5. Press the **Main** button in the Fat Channel to assign Aux Input 1 to the main output mix.

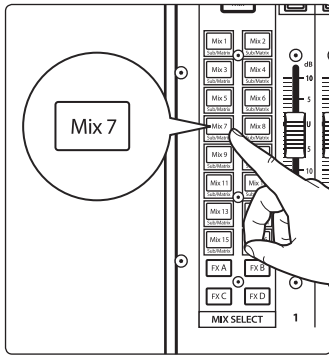

6. Press the **Mix 7** button in the Mix Select section to access settings for Aux 7 (the Aux mix you're using to send channels to the external processor). The faders move to show send levels to Aux 7 for each channel in your mix.
7. For each channel that you wish to send to the external processor, move the related fader to the desired level. Setting a fader higher makes the related channel sound more processed (or "wet").
8. Move the **Master** fader to adjust the overall level of the output you're sending to the external processor.
9. If you want to send a stereo signal (rather than mono) to your effects processor, connect a pair of Aux outputs, starting with an odd-numbered output (1 & 2, 3 & 4, or similar) to the inputs of your effects processor and link the output pair to create a stereo bus.

4.6.2 Subgroups

A subgroup allows you to combine multiple channels into a single bus so that the overall level for the entire group is controlled by a single fader and can be processed using the Fat Channel's noise gate, limiter, compression, and EQ, in addition to the processing available for each channel. Subgroups can also be soloed and muted.

You will find many uses for subgroups that will make mixing more convenient and will provide better control of your mix. At the end of this section, we explore one of the most common ways in which subgroups can help you to create a more efficient mixing environment and a more successful live mix. But first let's go over the subgroup controls.

Note: In addition to providing 16 FlexMixes that can function as subgroups, your StudioLive also provides four dedicated Subgroups.

To create a Subgroup:

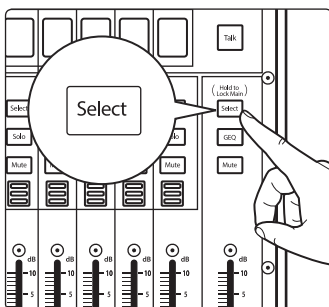

1. Press the **Select** button for the FlexMix Master you'd like to make a Subgroup.



2. Press the **Settings** button on the Master Control Touchscreen.

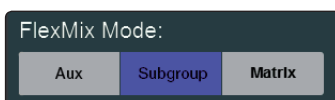

3. Press the **Subgroup** button under FlexMix Mode.

4.6.2.1 Creating Instrument Subgroups

Grouping individual instruments that create a section in your mix has obvious advantages: The entire group can be muted or soloed, brought up or down in a mix, and faded in or out for a more polished intro or outro. Because subgroups can also be processed by the Fat Channel, some common groups are drums, backing vocals, horn sections, and string sections. Drums are a classic application for subgroup mixing. While we'll use a drum group in this particular example, these principles can be applied when grouping any type of instrument section.

In this example, our drums will be connected to the StudioLive as follows:

- Channel 1: Kick
- Channel 2: Snare Top
- Channel 3: Snare Bottom
- Channel 4: Floor Tom
- Channel 5: Tom 1
- Channel 6: Tom 2
- Channel 7: Overhead Left
- Channel 8: Overhead Right
- Channel 9: Hi-Hat

We will create a stereo subgroup by first making both FlexMix 1 and 2 Subgroups and linking them to create a stereo bus.

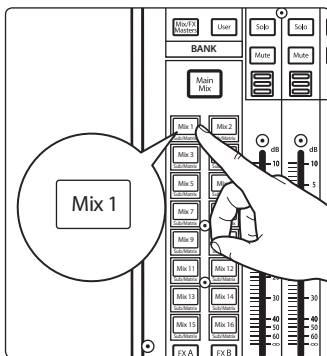

1. Press the **Mix 1** Select button.



2. In the Touch Screen, press the **Settings gear**.

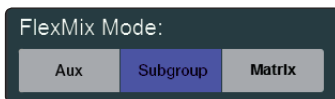

3. Press the **Subgroup** button under FlexMix Mode.

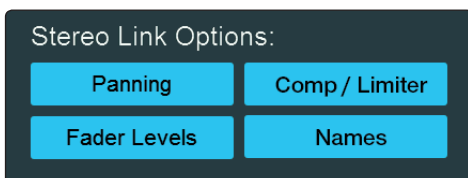

4. Enable all four Stereo Link Options.

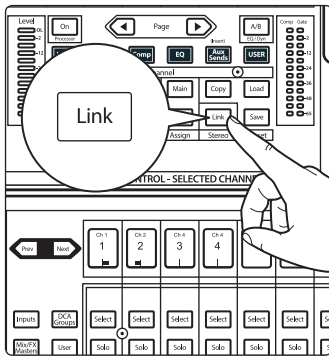

5. In the Fat Channel, press the **Stereo Link** button.

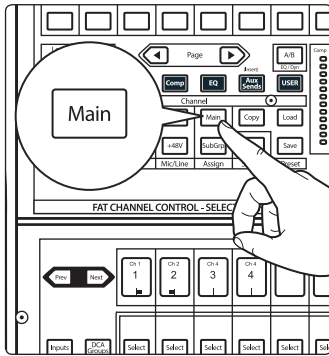

6. Assign the Subgroup to the Main bus by pressing the **Main assign** in the Fat Channel.

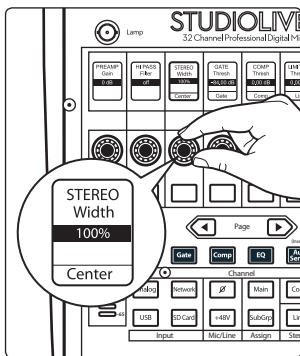

7. Turn the **Pan** knob all the way clockwise to set the stereo pan to hard left and right. Now Subgroups 1 and 2 are linked, with Sub 1 panned hard left and Sub 2 panned hard right. The channel panning is preserved.

Now that we've created a stereo subgroup, let's make an instrument group:

1. The first step is to get a good mix of the instruments you are grouping—in this case, the drums. Beginning with Channel 1 (Kick), raise the fader and, with the drummer's assistance, set the input trim, EQ, and dynamics for each drum separately.
2. As you select each channel and dial in its Fat Channel settings, assign each channel to be routed to Subgroups 1 and 2 and unassign it from the Main bus. When you are done with each channel, lower the fader before moving on. When you get to Channels 7 and 8 (Overheads), you may want to consider stereo linking them.

For more information on Subgroup routing assignments, *please refer to Section 5.5.*

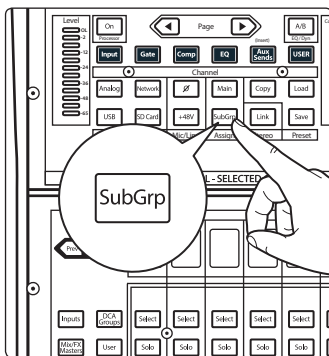

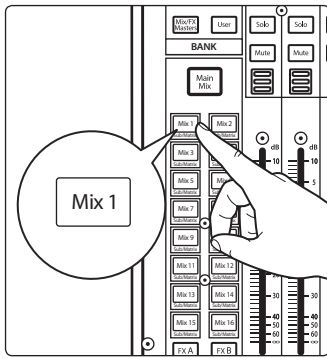

3. After you have gone through the entire kit and are satisfied with each channel's EQ and dynamics, have the drummer play the entire kit, and select the Mix 1 in the Mix Select area and set the relative volume and panning for each mic in the mix.

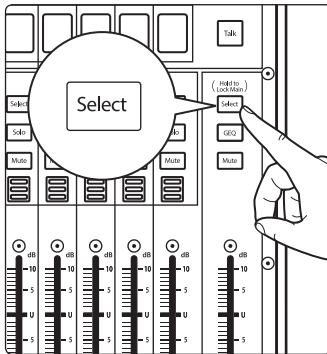

4. Press the FlexMix fader's **Select** button to use the Fat Channel section to add dynamics processing and EQ to the stereo drum group.

4.6.3 Matrix Mixes

On the simplest level, a matrix mix is a mix of mixes. A matrix mix allows you to combine any bus on your StudioLive as well as input channels. Matrix mixes can be the Swiss Army knife to solve some of the most problematic audio routing issues.

Here are some of the most common uses:

- Feeding the house mix to multiple locations (i.e. the lobby, a webcast feed)
- Creating a front fill mix

To create a Matrix Mix:

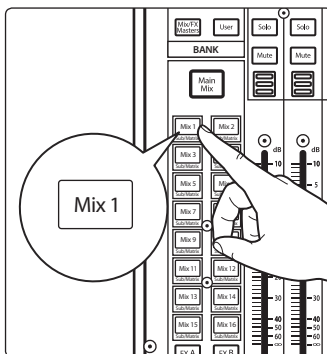

1. Press the **Mix Select** button for the FlexMix Master you'd like to make a Matrix mix.



2. Press the **Settings** button on the Master Control Touchscreen.

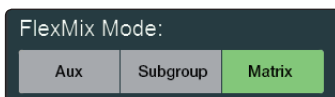

3. Press the **Matrix** button under FlexMix Mode

When you select your Matrix mix, the StudioLive buses will be on the first layer of inputs followed by the input channels.

4.6.3.1 Creating a Front Fill Mix

In some venues, the house PA doesn't cover the front rows effectively. This can be especially problematic in the band on stage is using in-ear monitors instead of floor wedges. Without floor wedges the people seated in the first few rows are actually "behind" the PA because they will hear more stage volume from the instruments on stage than from the front-of-house system. This problem can be solved by placing a few low profile speakers on the front edge of the stage to cover the first few rows of the audience.

You will want to blend the Main Left/Right mix at a low level with the source signals that may be difficult to hear, like the vocal and direct bass channels.

4.7 FX Buses

FX Buses act just like Aux mixes, but rather than feeding an output, they feed one of the StudioLive's internal effects processors. This allows you to customize the amount of a channel's signal that is being effected. Your StudioLive has four FX buses, each one feeding one the four internal bus FX processors: FX A, B, C, and D.

Pre/Post Channel Sends

Like Aux mixes, you can select the send position for each channel that is routed to an FX Mix. By default, all FX buses are set to Post. This places the send of every input channel to each FX bus after the fader, limiter, EQ, and compressor, Polarity Invert switch, high-pass filter, and gate. *See Section 4.6.1* for more information on the other available settings.

4.7.1 Creating Internal Bus FX Mixes

There are at least two main advantages to creating an effects mix instead of inserting an effect on a channel. First, several channels can be sent to a single processor. In addition to greatly simplifying the number of parameters you have to control, this can help to create a cohesive sound for your mix. Second, you can vary the level sent from each channel to the processor, rather than patching the output directly into the effect. This allows you to add a lot or a little of an effect to any given channel.

The four internal effects buses are used much in the same way the Aux buses are used to create monitor mixes. Let's create a mix for FX A:

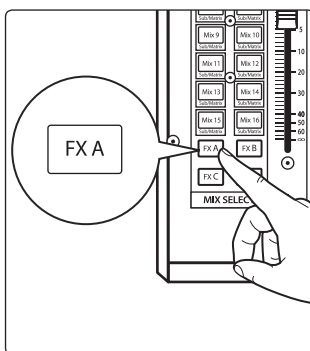

1. Press the **FX A** button in the Mix Select section to access settings for the FX A mix. The faders move to show FX A send levels for each channel in your mix.
2. For each channel that you wish to send to FX A, move the related fader to the desired level. Increasing the fader level increase how processed, or "wet", any given channel will sound.
3. Using the Fat Channel, you can apply Compression and EQ to the FX A Output. This can help quell unwanted resonances and make the effected signal sound more polished.
4. Move the Flex fader to adjust the overall level of the effected output of FX A.
5. The FX A bus has a return in every FlexMix as well as the Mains. To adjust the FX A Return in any mix, press its Mix Select button and navigate to the "FX A" channel.

4.8 Fixed Subgroups

In addition to the 16 FlexMixes, StudioLive mixers are equipped with four subgroups. Like the FlexMix Subgroups, the StudioLive allows you to group channels and apply the Fat Channel's noise gate, limiter, compression, and EQ to the group as a whole, in addition to the processing available for each channel. Subgroups can be soloed and muted. The StudioLive 32 provides dedicated Subgroup outputs on the back panel. Subgroups on the StudioLive 24 and 16 can be routed to the AVB network.



To view the fixed Subgroups, press the Mix/FX Masters button. This will bring up the master output control for every output bus.



Use the **Next** button to bank to the end of the FlexMixes.

To add a channel to a fixed Subgroup:

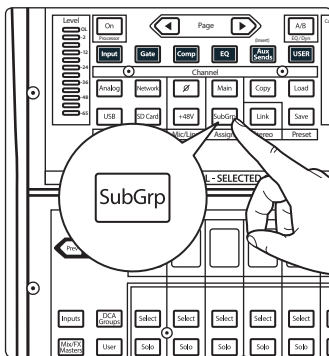

1. Select the channel and press the **Subgroup** button in the Assign section of the Fat Channel. This will bring up the Assigns menu on the Touchscreen.
2. The four fixed Subgroups are at the top of the screen. Touch the Subgroup to which you'd like to assign the channel.

For more information on Subgroup routing assignments, *please refer to Section 5.5.*

4.9 Talkback System

The StudioLive features a Talkback microphone input on the back panel. This can be routed to your choice of Aux outputs, as well as the Main output. The talkback signal is silent by default.



To enable talkback, press the **Talk** button.

To adjust the Talkback level in any mix, Press the **Aux Inputs** button and use the Talkback channel fader to set the desired level.

4.9.1 Talkback Edit Screen

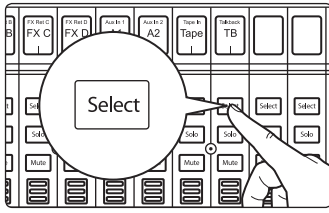

Press the Talkback Channel's **Select** button to open the Talkback Edit screen, giving you access to additional options.

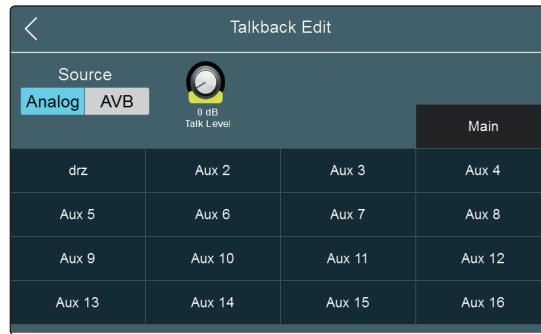

- **Source.** Sets the signal source for the Talkback channel. Select between **Analog** (Talkback mic input) and **AVB** (designated Talkback signal from a networked audio device).
- **Preamp Gain.** Sets the preamp gain for the Talkback mic input.
- **Talk Destination.** From this screen you can also select the mixes to which you'd like to route the Talkback input.

5 The Fat Channel

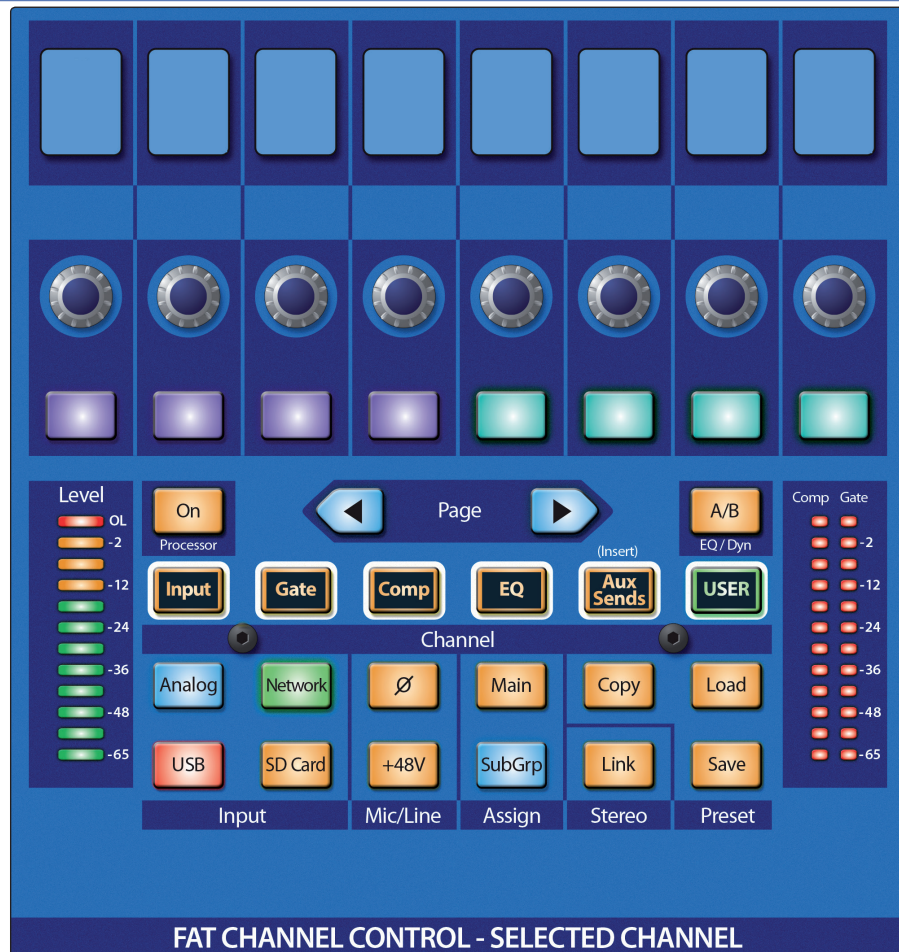

The Fat Channel gives you powerful signal processing, mixing, and configuration tools for each channel and bus on your StudioLive.

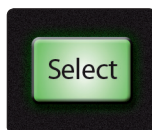

To begin working on a channel or mix with the Fat Channel, simply press its **Select** button. When you press a **Select** button, the number (and name, if applicable) of the selected channel or mix is shown on the touchscreen.

Mix Select buttons can be accessed one of two ways:

- Press the **Mix/FX Masters** button in the Bank section. This makes the mix and bus master faders available on the channel strips. Then, you can press the **Select** button that corresponds with the mix or bus you want to work with, bringing it into focus in the Fat Channel.
- Press the **Mix Select** button that corresponds with the mix or bus you want to work with. The Master fader on the mixer surface then addresses the master fader for that mix or bus. Press the **Select** button above the Master fader to access Fat Channel controls for that mix or bus.

The Fat Channel provides differing types of processing and utility settings depending on what type of channel or mix is selected. The following is a quick reference of the available processors and utility settings for each type of signal that the Fat Channel can process.

	Input Channels	Aux & Tape Inputs	FX Returns	FlexMixes	Main Mix
Preamp Gain	√	---	---	---	---
Hi Pass Filter	√	---	---	√	---
Pan	√	---	---	---	---
Gate	√	---	---	---	---
Compressor	√	√	√	√	√
EQ	4-Band	4-Band	4-Band	6-Band	6-Band
Limiter	√	---	---	√	√
USB / SD Send	√	√	---	---	---
Delay	√	---	---	√	√
Aux Sends	√	√	√	---	---
Aux Mute	√	√	√	---	---
Aux Pan	√	√	√	---	---

5.1 Fat Channel Navigation

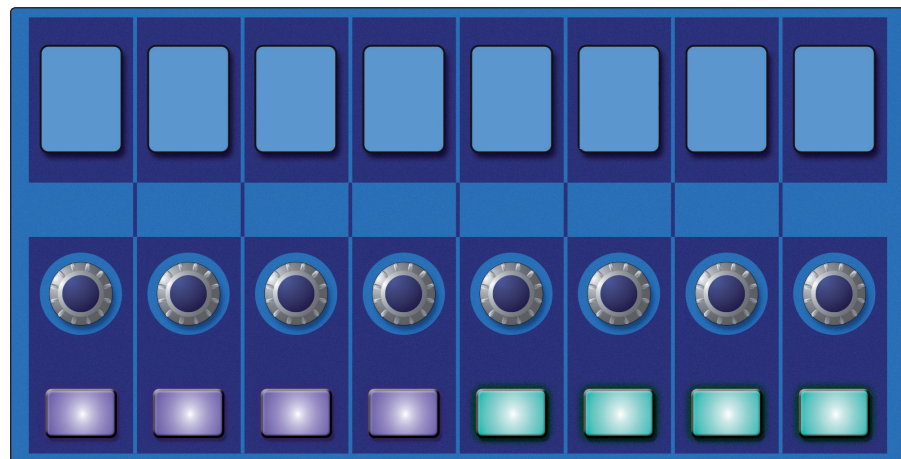

The eight Scribble Strip displays, encoders, and buttons at the top of the Fat Channel change dynamically to provide access to a variety of features and mixing tools. What is controlled here is determined by both the type of channel or bus that is selected and by the Fat Channel mode buttons.

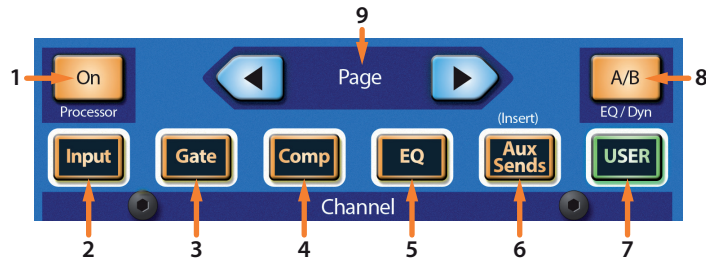

1. **Processor On/Off.** Enables/Disables the currently active processor.
2. **Input.** Displays the Fat Channel overview for the currently selected channel or bus in the Fat Channel and on the Touch Screen. *See Section 5.1.1.*
3. **Gate.** Displays the parameters for the noise gate in the Fat Channel and on the Touch Screen. *See Section 5.1.2*
4. **Comp.** Displays the parameters for the compressor in the Fat Channel and on the Touch Screen. *See Section 5.1.3.*
5. **EQ.** Displays the parameters for the compressor in the Fat Channel and on the Touch Screen. *See Section 5.1.4.*
6. **Aux Sends.** Displays the Aux Send levels, mutes, and pan controls for the currently selected channel. *See Section 5.1.5.*
7. **User.** Displays user-customizable parameters. *See Section 5.1.6.*
8. **Fat Channel A/B.** Switches between two different Fat Channel Settings. *See Section 5.2.*
9. **Prev/Next Page.** Navigates to additional parameters (if available).

5.1.1 Input Mode



Pressing the **Input** button in the Fat Channel gives you access to important controls and informative displays for the currently selected channel or mix.

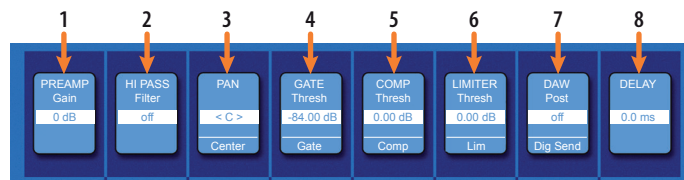

1. **Preamp Gain (Input Channels only).** Use the encoder to set the amount of preamp gain applied to the currently selected channel. The scribble strip displays the current gain level. *See Section 2.1* for proper gain staging.
2. **High-Pass Filter.** Use the encoder to set the High-Pass Filter Frequency Threshold for the Selected Channel or Output Bus. The filter's threshold can be set from 24 Hz to 1 kHz. When the threshold is set to its lowest point, the filter is off. The high-pass filter's slope is -12 dB/8va.

Power User Tip: A high-pass filter attenuates all frequencies below the set threshold. Use the Fat Channel high-pass filter to remove unwanted low-frequencies from your source signal, rather than trying to EQ them out.

3. **Pan (Input Channels only).** Use the encoder to set the currently selected channel's pan position across the stereo field. The pan position will be displayed on the Scribble Strip. Press the button below the encoder to reset the pan position to Center.
4. **Gate Threshold.** The encoder sets, and the scribble strip displays, the gate threshold for the selected channel. The gate threshold sets the level at which the gate opens. Essentially, all signals above the threshold setting are passed through unaffected, whereas signals below the threshold setting are reduced in level by the amount set by the range control. If the threshold is set fully counterclockwise, the gate is turned off (always open), allowing all signals to

pass through unaffected. You can set the threshold from 0 to -84 dB. *See Section 5.1.2* for more information on the Noise Gate and its parameters.

5. **Compressor Threshold.** This encoder sets, and the scribble strip displays, the compressor threshold for the selected channel or output bus. When the signal's amplitude (level) exceeds the threshold setting, the compressor engages. Turning the knob counterclockwise lowers the threshold so that compression begins at a lower amplitude. The threshold can be set from -56 to 0 dB. *See Section 5.1.3* for more information on the Compressor and its parameters.
6. **Limiter Threshold.** This encoder sets, and the scribble strip displays, the threshold of the limiter for the selected channel or output bus. When the signal's amplitude (level) exceeds the threshold setting, the limiter is engaged. Turning the knob counterclockwise lowers the threshold, so limiting begins at a lower amplitude. The Limiter ratio is ∞:1.
7. **Digital Send Pre/Post.** Use the encoder or button to toggle any digital sends from the current channel between pre-and-post-fader operation. Pre-fader mode means that send level is unaffected by channel fader level. Post-fader means that send level is scaled by channel fader level.
8. **Delay.** Sets the alignment delay for the currently selected input or bus. More information about input and output delays and be found in *Section 11.6 and 11.7*.

While an Input channel is selected and Input mode is active, the Channel Overview is displayed in the Touch Screen:

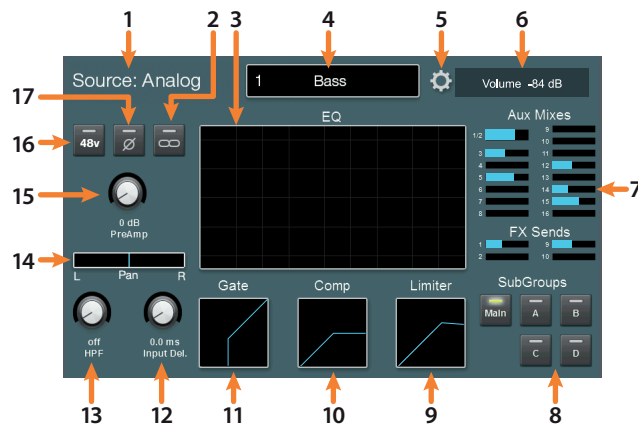

1. **Signal Source.** Displays whether this channel is receiving signal from an analog or digital source.
2. **Link.** Links or unlinks the channel to the adjacent channel or bus to create a stereo pair.
3. **EQ.** Displays the EQ overview. Touch to open the EQ Screen. *See Section 5.1.4* for more information.
4. **Name and Number.** Displays currently selected channel or bus name and number.
5. **Settings Button.** Touch to access additional channel or bus settings.
6. **Current Parameter.** Displays currently controlled parameter and its value.
7. **Aux and FX Send Levels.** Displays the send levels for current channel. Touch this area to open Channel Bus Sends screen. *See Section 5.1.5* for more information.
8. **Main and Subgroup Assignments.** Use these controls to assign/unassign the current channel to the Main bus and the four dedicated Subgroups.
9. **Limiter.** Displays the Limiter overview. Touch to open the Limiter Screen.
10. **Compressor.** Displays the Compressor overview. Touch to open the Compressor Screen. *See Section 5.1.3* for more information.
11. **Gate.** Displays the Noise Gate overview. Touch to open the Noise Gate Screen. *See Section 5.1.2* for more information.

12. **Delay.** Sets the amount of alignment delay applied to the input channel or bus. Touch to enable manipulation by the Master Control encoder. *See Section 11.6 and 11.7* for more information.
13. **HPF Frequency.** Sets the High Pass Filter cut-off frequency. Touch to enable manipulation by the Master Control encoder.
14. **Pan.** Sets the pan position. Touch to enable manipulation by the Master Control encoder.
15. **Preamp Gain.** Sets the preamp gain. Touch this knob to enable manipulation by the Master Control encoder.
16. **+48v.** Touch to enable/disable phantom power.
17. **Polarity Invert.** Touch to enable/disable polarity invert.

5.1.1.1 Channel Settings Screen



When the overview screen for a channel or bus is open, you can the Channel Settings screen by tapping on the Settings button (Call-out #5).



1. **Channel Name.** Touch the **name field** to enter a new name with the onscreen keyboard.
2. **Channel Type.** Touch the **type field** to choose between the standard identifying channel types (such as Guitars or Drums).
3. **Digital Send Options.** Touch **Pre** (signal is sent before Fat Channel processing) or **Post** (signal is sent after Fat Channel Processing) to choose the signal routing when sending this channel or bus to a USB or network-connected audio device.
4. **Channel Color.** Sets the color of a channel's Select button. If no color is selected, the Select button will be blue.
5. **Stereo Link Options.** These options let you specify the linking behavior when you link pairs of channels or buses, with the following options:
 - **Preamp Level/Trim.** Enable this option to link preamp level and trim settings when channels are linked. Disable to allow these settings to be individually set for each linked channel.
 - **Panning.** Enable this option for "stereo" panning mode, which lets you use the pan controls on linked channels or buses to control overall stereo "width." Moving a pan control on a linked channel moves the corresponding pan control the same amount in the opposite direction. Disable this option to allow independent panning of linked channels or buses.
 - **Fader Levels.** Enable this option to link volume faders for linked pairs of channels or buses. Disable it to allow independent manipulation of fader levels for linked channels.

- **Comp./Limiter.** Enable this option to link the compression & limiting detection behavior for linked channels or buses. With this option on, signals occurring either linked channel cause identical gain reduction behavior in both. Disable this option to let the compressor/limiter act independently on each linked channel.
- **Names.** Enable this option to keep linked channel/bus names identical. With this option on, a change to either name in a linked pair is reflected in the other linked channel.

Power User Tip: If one of the digital inputs (Network, USB, or SD) is selected as the channel source, you will be presented with the option to designate the Digital Send source as either Analog or Digital. This is a great way to use plugin processing as an insert. This is also necessary if you'd like to record an AVB or USB input to the SD recorder. For more information, please see the *StudioLive Software Library Manual*.

5.1.2 Gate Mode



Pressing the **Gate** button in the Fat Channel gives you access to the Noise Gate parameters for the selected channel or mix. A Gate is a dynamics processor that lets you silence (or attenuate) signals that fall beneath a chosen signal level. This makes it possible to reduce the presence of noise or other undesirable signals in the spaces between the sounds you want.

The Noise Gate can be switched to function as an Expander. An Expander is another type of dynamics processor, that works like a Compressor in reverse. Rather than attenuating signals that pass a chosen threshold level, an expander boosts signals that pass its threshold. This comes in handy when trying to restore punch and impact to signals that have been overly compressed, or which are not naturally as dynamic as desired.

Power User Tip: In practice, expanders and noise gates are used almost identically. The main difference is that an expander is smoother and more gradual, so that it is easier to set the attack and release times correctly.

The eight displays above the Gate/Expander controls show pertinent data about the current settings of these controls.

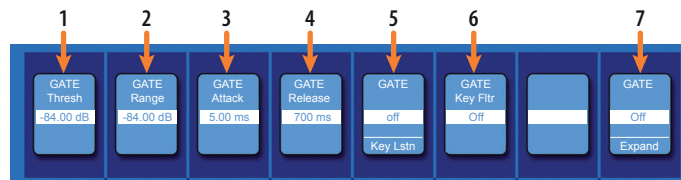

1. **Threshold.** Sets the signal level that bisects the signals you wish to keep from the signals you want to attenuate. Signals below this level are attenuated according to the setting of the Range parameter. Signals above this level pass through unaffected.
2. **Range.** Sets the amount of attenuation applied to a signal when its level falls below the Threshold. Lower settings pull signal level down further, all the way to $-\infty$, if desired. Higher settings pull the signal down to a lesser extent, de-emphasizing noise and other nuisance signals more subtly (without a "hard" cut-off). Note: Range is disabled when the Expander is engaged.
3. **Attack.** Sets the time it takes for the gate to "open" when a signal passes the threshold.

Power User Tip: A fast attack rate is crucial for percussive instruments. Slow-rising signals such as vocals and bass guitar require a slower attack; with these signals, a faster attack can cause an audible click. All gates have the ability to click when opening but a properly set gate will never click.

4. **Release.** Sets the time it takes for the gate to “close” when a signal falls beneath the threshold.

Power User Tip: Gate release times should typically be set so that the natural decay of the instrument or vocal being gated is not affected. Shorter release times help to clean up the noise in a signal but may cause “chattering” with percussive instruments. Longer release times usually eliminate chattering and should be set by listening carefully for the most natural release of the signal.

5. **Key Listen.** Press the button to engage or disengage the Key Listen function in the solo bus. It will illuminate to indicate that the Key Listen is active. When Key Listen is enabled, and the selected channel is soloed, you can use the Control Room outputs to monitor what the gate key filter is removing.
6. **Key Filter.** This encoder sets, and the scribble displays, the frequency at which the gate will open. Setting a specific frequency, in addition to a specific decibel level, provides more sonic shaping.

Power User Tip: A properly set key filter on a gate can greatly improve the overall sound quality of a mix. For example, if you are inserting a gate on a snare-drum mic, you may get enough bleed from the kick drum to open the gate. This is where a key filter can come in handy. By setting the key filter to remove some of those low frequencies, the gate won't be as apt to open for the kick drum.

7. **Expander Mode.** Press the button or turn the encoder to switch between Gate and Expander functions for this processor. See the next section of this manual for information on available parameters when in Expander mode.



Press the **Processor** button to turn the Gate on or off.

When the Fat Channel is in Gate/Expander mode, the touchscreen shows an overview screen, displaying the relevant parameters (as available in the Fat Channel), along with useful metering and a graphical representation of the effect of current settings. Touching any onscreen knob allows you to use the Master Control encoder to set the selected parameter. Touching a drop-down selector (such as Key Source) lets you select from a list of relevant choices. Use the Master Control encoder to scroll through choices. Touching onscreen buttons toggles the related parameter on or off.

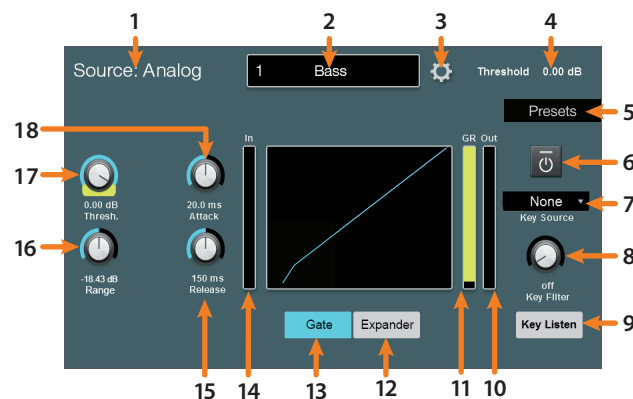

1. **Signal Source.** Displays whether this channel is receiving signal from an analog or digital source.
2. **Channel Name & Number.** Displays currently selected channel name and number.
3. **Settings Button.** Touch to access additional channel settings.
4. **Current Parameter.** Displays currently controlled parameter and its value.
5. **Presets.** Opens the Preset Library. *See Section 5.8* for more information.
6. **Gate On/Off.** Turns the Gate on or off for the current channel or bus.
7. **Key Source (Input Channels only).** The encoder sets and the scribble strip displays the input signal that will trigger the gate. This method of triggering a dynamics processor is often called sidechaining. Set to “None” to disable sidechaining. For more information on Sidechaining, *see Section 5.1.2.1*. Press the button below to listen to the signal being used to trigger the gate (either the key source or the key filter). Press again to switch back to the normal channel signal

8. **Key Filter.** Sets the Key Filter frequency.
9. **Key Listen.** Touch to enable the Key Listen function.
10. **Output Meter.** Displays the post-Gate signal level.
11. **Gain Reduction Meter.** Displays the amount of Gain Reduction applied by the Gate to the channel.
12. **Expander.** Enables the Expander.
13. **Gate.** Enables the Gate.
14. **Input Meter.** Displays the pre-Gate signal level.
15. **Release.** Sets the Release time for the Gate/Expander.
16. **Range.** Sets the Range for the Gate.
17. **Threshold.** Sets the Threshold for the Gate/Expander.
18. **Attack.** Sets the Attack time for the Gate/Expander.

Power User Tip: Use the Tap button to “null” button any parameter by pressing and holding the Tap button while adjusting the control of your choice to return that control to its default setting

5.1.2.1 Sidechaining the Gate

As previously mentioned, the Gate's key filter can be sidechained to another channel. This allows you to select a different channel as the trigger source for your StudioLive Gate's Key Filter. Sidechaining has many uses:

Tighten up a Rhythm Section. You can use a sidechained key filter to tighten up a rhythm section by sidechaining the kick drum channel to the bass channel and setting the gate to open at the frequency of the kick drum. This, combined with a fast attack and release, will make your rhythm section more cohesive. Increase the release time to loosen the feel.

Rhythmic Effect. Another great use for a sidechain is as an effect in EDM production. Try sidechaining a drum loop to a sustained source, like pads or strings. By doing this, every time a drum hit triggers the key filter, your sustained source will be heard. Between hits, this source will be silenced. Playing with the attack and release will transform this effect from a rhythmic pulse all the way to a chopped-up stutter.

This tutorial will guide you through the first use case. Please note, that while sidechaining the kick drum to the bass channel can tighten up a good rhythm section and make them sound even better, it will not correct timing issues and will actually exaggerate them if your bass player and drummer aren't in the pocket.

For this purposes of this tutorial, we'll use the dynamics of the kick drum on Channel 1 to trigger the gate for the bass on Channel 15.

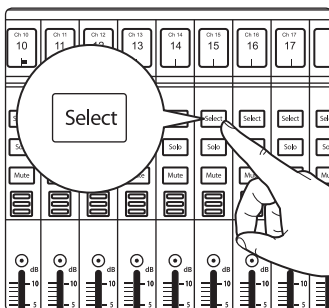

1. Press the **Select** button on the bass channel, to bring it into focus in the Fat Channel.

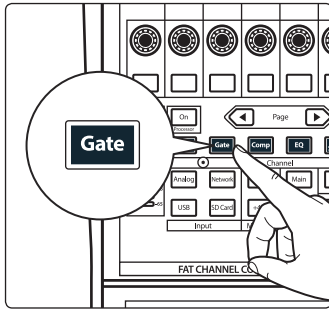

2. Press the **Gate** button in the Fat Channel, to access gate/expander controls for the bass channel.

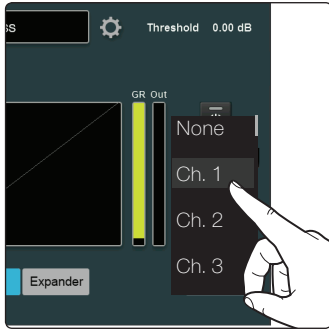

3. Select the kick drum channel as the Key Source or by using the Key Source selector on the touchscreen.

4. Adjust the **Threshold**, **Attack**, and **Release** controls to create the gating effect you're looking for.

If you want to break the sidechain connection, set Key Source for the gate back to "None."

5.1.3 Compressor Mode



Pressing the **Comp** button in the Fat Channel gives you access to the Compressor parameters for the selected channel or mix. A compressor is a dynamics processor that reduces the dynamic range of a signal by attenuating it by a set ratio when it exceeds a defined threshold.

This lets you tame transients in a signal and increase its overall level (if desired). It also lessens the risk of peaking and the resulting distortion. Compressing a signal and raising its level also lets you accentuate subtle details (such as room reverberation or ghost notes) which might otherwise go unheard.

The Fat Channel gives you the following distinct compressor models to choose from, each with its own set of controls and its own behavior.

- **Standard Compressor.** A clean and full-featured compressor that offers transparent dynamic range reduction.
- **Tube Leveling Amplifier.** A model of a tube-based optoelectronic compressor, with simple, quick controls and a classic tonal character.
- **Class-A FET Leveling Amplifier.** A model of a Class-A FET-based compressor, with an aggressive, punchy tonal character.

The eight Scribble strips in the Fat Channel show pertinent data about the current settings of these controls. The controls differ, based on the model of compressor you select.

Power User Tip: Use the **Tap** button to "null" button any parameter by pressing and holding the Tap button while adjusting the control of your choice to return that control to its default setting.

The compressor models can be selected from the Touchscreen when Compressor mode is active in the Fat Channel:

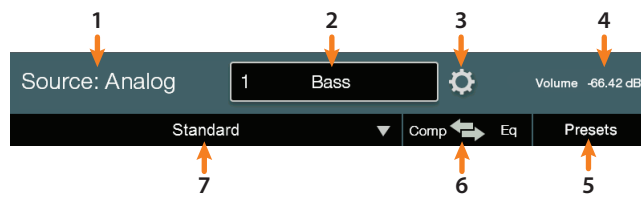

1. **Signal Source.** Displays whether this channel is receiving signal from an analog or digital source.
2. **Name and Number.** Displays currently selected channel or bus name and number.
3. **Settings Button.** Touch to access additional settings.
4. **Current Parameter.** Displays currently control parameter and its value.
5. **Presets.** Opens Presets menu on the Touchscreen.
6. **Comp>EQ.** The Compressor and EQ can be reordered in the signal path. By default, the signal passes through the compressor before passing through EQ. When reordered, the EQ is placed before the compressor in the signal path.
7. **Compressor Type.** Changes the type of Compressor model.

Power User Tip: Placing the compressor before the EQ allows you to make dramatic changes to the EQ settings without needing to alter the compressor setting. However, if you place the EQ before the compressor, you can better control different frequencies, achieving a more natural response.

5.1.3.1 Standard Compressor

The Standard Compressor is selected on every channel by default.

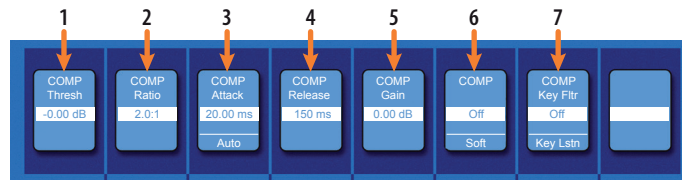

1. **Threshold.** Sets the level above which the compressor begins to attenuate the signal.
2. **Ratio.** Sets the relationship between the amount a signal goes above the threshold, and the amount it is attenuated. At a 1-to-1 ratio (often written as 1:1), no compression occurs. At a 4:1 ratio, a signal that passes the threshold by 8 dB is attenuated to within 2 dB of the threshold (dividing by four). The higher the ratio you choose, the more pronounced the compressor effect becomes.
3. **Attack.** Sets the time it takes for the compressor to begin attenuating a signal, once it passes the threshold. Press the button below to toggle Auto mode on or off. When Auto mode is active, the Attack and Release controls become inoperative, and a preprogrammed attack and release curve is used. In this mode, the attack is set to 10 ms, and the release is set to 150 ms. All other compressor parameters can still be adjusted manually.
4. **Release.** Sets the time it takes for the compressor to stop attenuating a signal once it falls below the threshold.

Power User Tip: Very short compressor release times can produce a choppy or “jittery” sound, especially when compressing instruments that have a lot of low-frequency components, such as bass guitar. Very long release times can result in an over-compressed, or “squashed,” sound. All ranges of release can be useful, however, and you should experiment to become familiar with different sonic possibilities.

5. **Gain.** Sets the amount of “makeup gain” to apply to a signal. Once a signal is compressed, its overall level is often reduced. This gain control lets you bring it back up to the proper level after compression occurs.
6. **Compressor Knee Soft/Hard.** Press this button to toggle the compressor between soft and hard-knee modes. Soft-knee compression offers a smooth transition between uncompressed and compressed states. Hard-knee compression offers a more abrupt transition, and more exacting protection from stray peaks.
7. **Key Filter.** This encoder sets, and the scribble displays, the frequency at which the compressor will engage. The compressor will still process the entire frequency range, but it is only engaged when the specified frequency is present. Press the button below to listen to the signal being used to trigger the compressor (including the effects of the high-pass filter, as set with the Key Filter control). Press again to switch back to the normal channel signal.



Press the **Processor** button to turn the Compressor on or off.

When the Fat Channel is in Standard Compressor mode, the touchscreen shows an overview screen that displays the relevant parameters (as available in the Fat Channel), along with useful metering and a graphical representation of the effect of current settings. Touching any onscreen knob allows you to use the Master Control encoder to set the selected parameter. Touching a drop-down selector (such as Key Source) lets you select from a list of relevant choices. Use the Master Control encoder to scroll through choices. Touching onscreen buttons toggles the related parameter on or off.

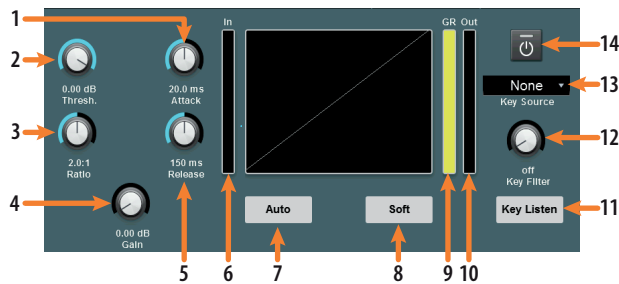

1. **Attack.** Sets the Attack time for the Compressor.
2. **Threshold.** Sets the Threshold for the Compressor.
3. **Ratio.** Sets the Compressor Ratio.
4. **Gain.** Sets Make-up Gain for the Compressor.
5. **Release.** Sets the Release time for the Compressor.
6. **Input Meter.** Displays the pre-Compressor signal level.
7. **Auto.** Enables Auto Mode.
8. **Soft.** Enables Soft knee compression.
9. **Gain Reduction Meter.** Displays the amount of Gain Reduction applied by the Compressor to the channel.
10. **Output Meter.** Displays the post-Compressor signal level.
11. **Key Listen.** Touch to enable the Key Listen function.
12. **Key Filter.** Sets the Key Filter frequency.
13. **Key Source (Input Channels only).** Sets the Key Source for the Compressor.
14. **Processor On/Off.** Enables or disables the Compressor.

5.1.3.2 Tube Leveling Amplifier

When the Tube Leveling Amplifier is selected, the following controls are available in the Fat Channel:

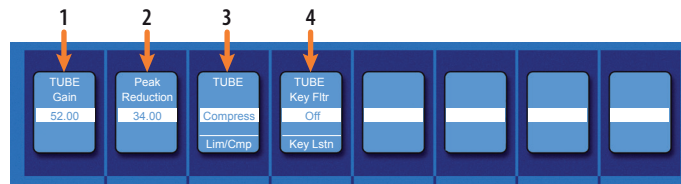

1. **Gain.** Sets input gain to the compressor. Because this type of compressor operates in a different way than a standard compressor, much of the way that it affects signals is based on the input level. Try different settings to see what suits your needs.
2. **Peak Reduction.** Sets the amount of peak reduction to apply to the signal. Higher settings result in more gain reduction and more pronounced compression effect.
3. **Compressor/Limiter Toggle.** The button below toggles the Tube Leveling Amplifier between its compressor and limiter modes. When in compressor mode, it acts with a variable ratio of 1:1-10:1. When in limiter mode, it acts with a variable ratio of 10:1-20:1, more aggressively limiting peaks.
4. **Key Filter.** This encoder sets, and the scribble displays, the frequency at which the Tube Leveling Amplifier will engage. It will still process the entire frequency range, but it is only engaged when the specified frequency is present. Press the button below to listen to the signal being used to trigger the compressor (including the effects of the high-pass filter, as set with the Key Filter control). Press again to switch back to the normal channel signal.



Press the **Processor** button to turn the Compressor on or off.

When the Fat Channel is in Tube Compressor mode, the touchscreen shows an overview screen that displays the relevant parameters (as available in the Fat Channel). Touching any onscreen knob allows you to use the Master Control encoder to set the selected parameter. Touching a drop-down selector (such as Key Source) lets you select from a list of relevant choices. Use the Master Control encoder to scroll through choices. Touching onscreen buttons toggles the related parameter on or off.

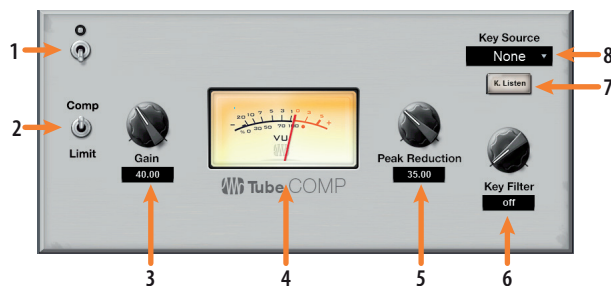

1. **Processor On/Off.** Enables or disables the Compressor.
2. **Comp / Limiter.** Switches between the compressor and limiter modes.
3. **Gain.** Sets the input gain to the compressor.
4. **VU Meter.** Displays the post-Compressor signal level.
5. **Peak Reduction.** Sets the amount of peak reduction to apply to the signal.
6. **Key Filter.** Sets the Key Filter frequency.
7. **Key Listen.** Touch to enable the Key Listen function.
8. **Key Source (Input Channels only).** Sets the Key Source for the Compressor.

5.1.3.3 Class-A FET Leveling Amplifier

When the Class-A FET Leveling Amplifier is selected, the following controls are available in the Fat Channel:

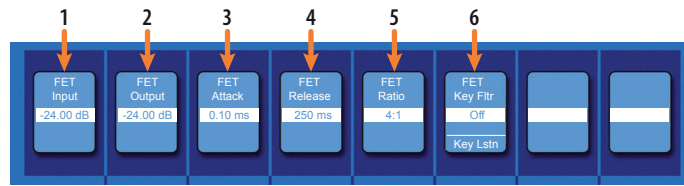

1. **Input Gain.** Sets input gain to the compressor. This setting affects the action of the compressor, so feel free to try various settings to find the optimal effect for your needs.
2. **Output Gain.** Sets the amount of “makeup gain” to apply to a signal. Once a signal is compressed, its overall level is often reduced. This gain control lets you bring it back up to the proper level after compression occurs.
3. **Attack.** Sets the time it takes for the compressor to begin attenuating a signal once it passes the threshold.
4. **Release.** Sets the time it takes for the compressor to stop attenuating a signal once it falls below the threshold.
5. **Ratio.** Sets the Ratio for the compressor. The following Ratios are available: 4:1, 8:1, 12:1, 20:1, or All.
6. **Key Filter.** This encoder sets, and the scribble displays, the frequency at which the compressor will engage. The compressor will still process the entire frequency range, but it is only engaged when the specified frequency is present. Press the button below to listen to the signal being used to trigger the compressor (including the effects of the high-pass filter, as set with the Key Filter control). Press again to switch back to the normal channel signal.



Press the **Processor** button to turn the Compressor on or off.

When the Fat Channel is in Class A FET Compressor mode, the touchscreen shows an overview screen that displays the relevant parameters (as available in the Fat Channel). Touching any onscreen knob allows you to use the Master Control encoder to set the selected parameter. Touching a drop-down selector (such as Key Source) lets you select from a list of relevant choices. Use the Master Control encoder to scroll through choices. Touching onscreen buttons toggles the related parameter on or off.



1. **Processor On/Off.** Enables or disables the Compressor.
2. **Input.** Sets the input gain to the compressor.
3. **Output.** Sets the make-up gain for the compressor.
4. **Attack.** Sets the attack time for the compressor.
5. **Release.** Sets the release time for the compressor.
6. **VU Meter.** Displays the post-Compressor signal level.
7. **Ratio.** Sets the ratio for the compressor.
8. **Key Filter.** Sets the Key Filter frequency.
9. **Key Listen.** Touch to enable the Key Listen function.
10. **Key Source (Input Channels only).** Sets the Key Source for the Compressor

5.1.3.4 Sidechaining the Compressor

Sidechaining a compressor allows you to reduce the level of one input source to make room for another. This is especially useful in live broadcast or application where music and commentary are happening simultaneously. In recording applications, this is generally accomplished with careful level automation. Compressor sidechaining allows you to achieve a similar result without having to ride the faders.

Below are two of the most common uses:

Dialogue Ducking. This is probably the most well-known compressor sidechaining application. Consider a common House of Worship situation where the pastor is leading a meditation while the piano or pre-recorded music is being played. Apply a compressor on the stereo music track with a fairly low threshold, high ratio, a fast attack and a long release time, using the pastor's microphone channel as the key source for the compressor. Now the compressor will react to level fluctuations from the pastor's microphone, allowing the music to naturally rise and fall in counterpoint to the speech pattern.

Bringing Out the Kick Drum. In some instances, a synth bass line, or a busy bass guitar part interferes with the kick drum presence and punch in the mix. For this application, you will apply a compressor to the bass channel, using the kick drum channel as the key source, allowing your kick drum to punch through the bass line.

5.1.4 EQ Mode



Pressing the **EQ** button in the Fat Channel gives you access to equalization settings for the currently selected channel or mix. An EQ (or equalizer) is a tone control that lets you make changes in the tonal balance of a signal. You can boost or cut the level of ranges of frequencies, to make corrective or creative changes to the signal.

The Fat Channel gives you the following distinct EQ models to choose from, each with its own set of controls and its own behavior.

- **Standard EQ.** A clean and full-featured EQ that offers transparent tone shaping.
- **Passive Program EQ (Input Channels only).** A model of a tube-based EQ with simple, quick and a classic tonal character.
- **Vintage 1970s EQ (Input Channels only).** A model of a classic solid-state EQ, with simple, musical frequency settings and a lot of character.

The eight Scribble Strips in the Fat Channel show pertinent data about the current settings of these controls. The controls differ, based on the model of EQ you select.

***Power User Tip:** Use the Tap button to "null" button any parameter by pressing and holding the Tap button while adjusting the control of your choice to return that control to its default setting.*

The EQ models can be selected from the Touchscreen when Compressor mode is active in the Fat Channel:

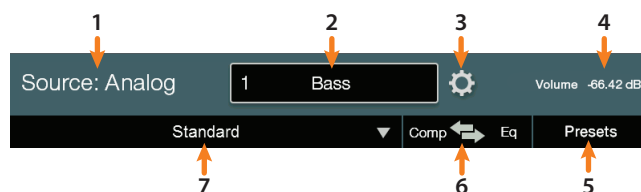

1. **Signal Source.** Displays whether this channel is receiving signal from an analog or digital source.
2. **Name and Number.** Displays currently selected channel or bus name and number.
3. **Channel Settings Button.** Touch to access additional channel settings.
4. **Current Parameter.** Displays currently control parameter and its value.
5. **Presets.** Opens Presets menu on the Touchscreen.

6. **Comp>EQ.** The Compressor and EQ can be reordered in the signal path. By default, the signal passes through the compressor before passing through EQ. When reordered, the EQ is placed before the compressor in the signal path.

Power User Tip: *Placing the compressor before the EQ allows you to make dramatic changes to the EQ settings without needing to alter the compressor setting. However, if you place the EQ before the compressor, you can better control different frequencies, achieving a more natural response.*

7. **EQ Type.** Changes the type of EQ model

5.1.4.1 Standard EQ

The Standard EQ is selected on every channel by default:

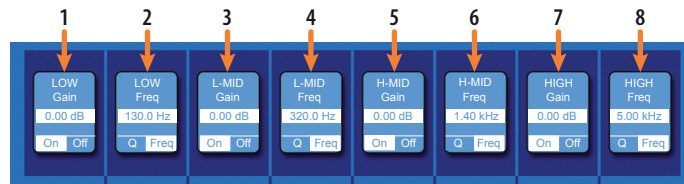

1. **Band 1 / Low Gain.** Sets the amount by which the selected frequency will be boosted or cut. Press the button below to turn the band on or off.
2. **Band 1 / Low Frequency/Q.** The encoder can control either frequency or Q for this band of EQ. Use the button below to toggle between the two. When in Frequency mode, it sets the center frequency at which signals are boosted or cut by this band of EQ. When in Q mode, it sets the Q (or width) of the current EQ band. Larger Q values affect a narrower range of frequencies. Lower Q values affect a wider range.
3. **Band 2 / Low-Mid Gain.** Sets the amount by which the selected frequency will be boosted or cut. Press the button below to turn the band on or off.
4. **Band 2 / Low-Mid Frequency/Q.** The encoder can control either frequency or Q for this band of EQ. Use the button below to toggle between the two. When in Frequency mode, it sets the center frequency at which signals are boosted or cut by this band of EQ. When in Q mode, it sets the Q (or width) of the current EQ band. Larger Q values affect a narrower range of frequencies. Lower Q values affect a wider range.
5. **Band 3 / High-Mid Gain.** Sets the amount by which the selected frequency will be boosted or cut. Press the button below to turn the band on or off.
6. **Band 3 / High-Mid Frequency/Q.** The encoder can control either frequency or Q for this band of EQ. Use the button below to toggle between the two. When in Frequency mode, it sets the center frequency at which signals are boosted or cut by this band of EQ. When in Q mode, it sets the Q (or width) of the current EQ band. Larger Q values affect a narrower range of frequencies. Lower Q values affect a wider range.
7. **Band 4 / High Gain.** Sets the amount by which the selected frequency will be boosted or cut. Press the button below to turn the band on or off.
8. **Band 4 / High Frequency/Q.** The encoder can control either frequency or Q for this band of EQ. Use the button below to toggle between the two. When in Frequency mode, it sets the center frequency at which signals are boosted or cut by this band of EQ. When in Q mode, it sets the Q (or width) of the current EQ band. Larger Q values affect a narrower range of frequencies. Lower Q values affect a wider range.



When a bus is selected, the EQ has six bands. Use the **Page navigation** buttons to navigate between Bands 1-4 and Bands 5-6.



Press the **Processor** button to turn the EQ on or off.

When the Fat Channel is in EQ mode, the touchscreen shows an EQ overview screen, displaying the relevant parameters (as available in the Fat Channel), along with useful metering and a graphical representation of the effect of current settings. Touching any onscreen knob (or EQ node, in the Standard EQ) allows you to use the Master Control encoder to set the selected parameter. Touching a drop-down selector (such as Key Source) lets you select from a list of relevant choices. Use the Master Control encoder to scroll through choices. Touching onscreen buttons toggles the related parameter on or off.

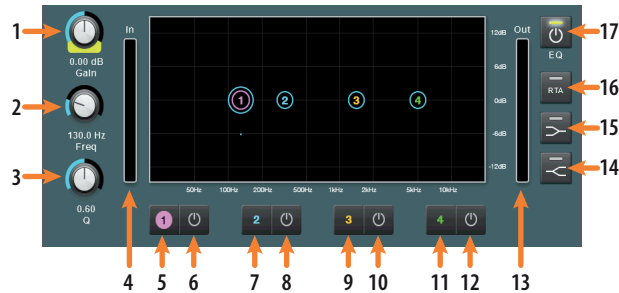

1. **Gain.** Controls the amount of boost or cut applied to the frequency of the currently selected band (Call-out #5, 7, 9, or 11).
2. **Frequency.** Sets the center frequency for the currently selected band (Call-out #5, 7, 9, or 11).
3. **Q.** Sets the Q for the currently selected band (Call-out #5, 7, 9, or 11).
4. **Input Meter.** Displays the Input signal to the EQ.
5. **Band 1 Select.** Selects Band 1 for control via Gain (#1), Frequency (#2), and Q (#3).
6. **Band 1 On/Off.** Enables/disables Band 1.
7. **Band 2 Select.** Selects Band 2 for control via Gain (#1), Frequency (#2), and Q (#3).
8. **Band 2 On/Off.** Enables/disables Band 2.
9. **Band 3 Select.** Selects Band 3 for control via Gain (#1), Frequency (#2), and Q (#3).
10. **Band 3 On/Off.** Enables/disables Band 3.
11. **Band 4 Select.** Selects Band 4 for control via Gain (#1), Frequency (#2), and Q (#3).
12. **Band 4 On/Off.** Enables/disables Band 4.

Note: When one of the output buses is selected, Bands 5 and 6 will also be visible.

13. **Output Meter.** Displays the post-EQ Output signal.
14. **High Shelf On/Off.** Enables/disables the high shelf EQ. When the Shelf button is not engaged, the High band is a parametric EQ. Enabling the Shelf button turns the High band into a high shelving EQ that alters, by a fixed amount, a band of high frequencies at and above a user-selected shelving frequency.

Power User Tip: A high shelving EQ is like a treble-control knob on a stereo. In this mode, the Center Frequency control selects the shelving frequency.

15. **Low Shelf On/Off.** Enables/disables the low shelf EQ. When the Shelf button is not engaged, the Low band is parametric. Enabling the Shelf button turns the Low band into a low-shelving EQ that alters, by a fixed amount, a band of low frequencies at and below a user-selected shelving frequency.

Power User Tip: A low shelving EQ is like a bass-control knob on a stereo. In this mode, the Center Frequency control selects the shelving frequency.

16. **RTA.** Engages/disengages the RTA display in the EQ graph.
17. **EQ On/Off.** Globally switches all EQ bands On or Off.

5.1.4.2 Passive Program EQ

When the Passive EQ is selected, the following controls are available in the Fat Channel:

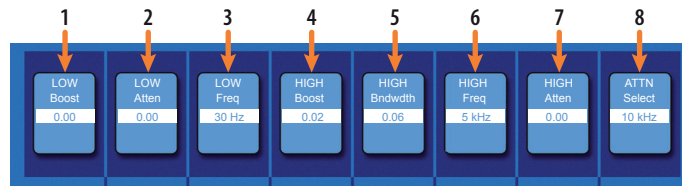

1. **Low Boost.** Sets the level of boost applied around the chosen low frequency. This control interacts nicely with the Low Attenuation control, allowing for boosts in apparent bass energy while keeping overall bass energy within optimal limits.
2. **Low Attenuation.** Sets the level of attenuation applied around the chosen low frequency. This control interacts nicely with the Low Boost control, allowing for boosts in apparent bass energy while keeping overall bass energy within optimal limits.
3. **Low Frequency Select.** Sets the center frequency of the band covered by the Low Boost and Low Attenuation controls.
4. **High Boost.** Sets the level of boost applied around the chosen high frequency.
5. **High Bandwidth.** Sets the Q (or width) of the effect of the high EQ band.
6. **High Frequency.** Sets the center frequency of the high EQ band.
7. **High Attenuation.** Sets the amount of attenuation applied in a shelving fashion to frequencies at and above the chosen high frequency.
8. **Attenuation Select.** Sets the frequency at and above which the High Attenuation control attenuates treble content.



Press the **Processor** button to turn the EQ on or off.

When the Fat Channel is in Passive EQ mode, the touchscreen shows an overview screen, displaying the relevant parameters (as available in the Fat Channel). Touching any onscreen knob allows you to use the Master Control encoder to set the selected parameter.

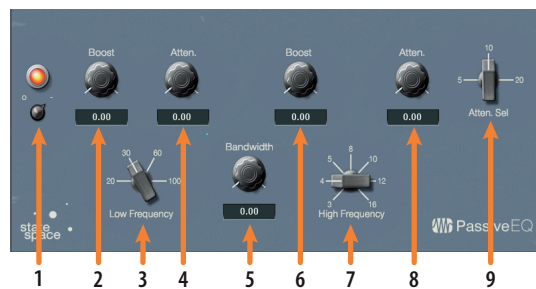

1. **EQ On/Off.** Enables/disables the EQ globally. Touch to toggle on or off
2. **Low Boost.** Boosts the Low Band.
3. **Low Frequency.** Sets the center frequency for the Low Band.
4. **Low Attenuation.** Attenuates the Low Band.
5. **High Bandwidth.** Sets the bandwidth (Q) for the High Band.
6. **High Boost.** Boosts the High Band.
7. **High Frequency.** Sets the center frequency for the High Band.
8. **High Attenuation.** Sets the attenuation for the High Band.
9. **Attenuation Select.** Sets the Frequency at which the attenuation begins.

5.1.4.3 Vintage 1970s EQ

When the Vintage 1970s EQ is selected, the following controls are available in the Fat Channel:

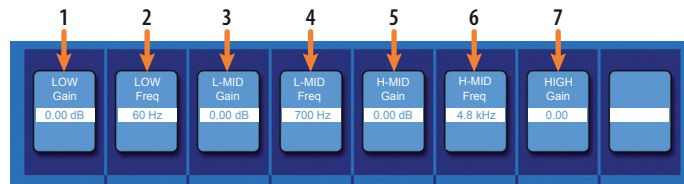

1. **Low Gain.** Sets the amount of boost or cut to apply the low-frequency band of this EQ.
2. **Low Frequency.** Sets the shelving frequency of the low-frequency band of this EQ.
3. **Lo-Mid Gain.** Sets the amount of boost or cut to apply the low-mid-frequency band of this EQ.
4. **Lo-Mid Frequency.** Sets the center frequency of the low-mid-frequency band of this EQ.
5. **Hi-Mid Gain.** Sets the amount of boost or cut to apply the high-mid-frequency band of this EQ.
6. **Hi-Mid Frequency.** Sets the center frequency of the high-mid-frequency band of this EQ.
7. **High Gain.** Sets the amount of boost or cut to apply the high-frequency band of this EQ.



Press the **Processor** button to turn the EQ on or off.

When the Fat Channel is in Vintage EQ mode, the touchscreen shows an overview screen, displaying the relevant parameters (as available in the Fat Channel).



1. **EQ On/Off.** Enables/disables the EQ globally. Touch to toggle on or off.
2. **Low Frequency.** Sets the shelving frequency for the Low Band.
3. **Low Gain.** Sets the Gain for the Low Band.
4. **Low-Mid Frequency.** Sets the center frequency for the Low-Mid Band.
5. **Low-Mid Gain.** Sets the Gain for the Low-Mid Band.
6. **High-Mid Frequency.** Sets the center frequency for the High-Mid Band.
7. **High-Mid Gain.** Sets the Gain for the High-Mid Band.
8. **High Gain.** Sets the Gain for the High Band.

5.1.4.4 Using the RTA While Mixing

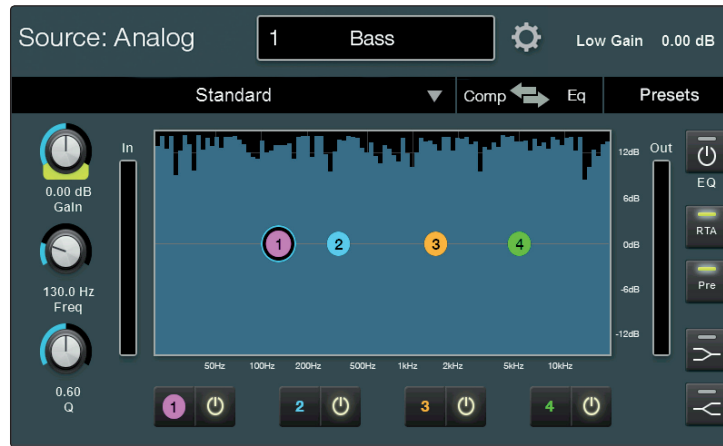

The Standard EQ is equipped with a Real-time analyzer, or RTA, in which $x =$ frequency and $y =$ amplitude. An RTA provides a close visual representation of what you are hearing because it is a view of amplitude and frequency content over a specified plane in real time. It provides a view of the long-term spectrum of the signal—for example, the one- third-octave spectrum long-term average of a musical performance.

The ability to analyze frequency content—specifically, being able to visualize the exact frequencies you are hearing in order to hone in on problem areas— makes the RTA a secret weapon for many a mix engineer. The RTA also lends itself very well to ear training and gives you confidence that you are choosing the right frequencies when making adjustments.

Because the RTA is analyzing the channel or bus signal digitally, room and speaker anomalies are taken out of the equation. This provides a pure measurement of your mix because you are measuring what is happening inside your StudioLive.

For example, let's say you are mixing a particularly edgy-sounding lead guitar that is competing with the male vocal and distracting from the overall good tone of the instrument. By using the RTA in the Fat Channel, you can quickly identify the offending frequency by looking for spikes in the RTA. This saves time and frustration by taking some of the guesswork out of equalization.

Power User Tip: It should be noted that an RTA cannot be used as a substitute for careful listening. While these tools provide a great visual analysis of your mix, critical listening must always be your main guide.

5.1.5 Aux Sends Mode



When the Fat Channel is in Aux Sends mode, the Scribble Strips will display different parameters depending on how you have your FlexMixes configured:

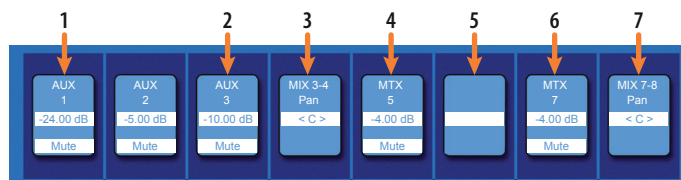

1. **Mono Aux.** The encoder controls the send level of the channel to the Mono Aux. The button beneath controls the channel mute in the Mono Aux.
2. **Stereo Aux Send.** The encoder controls the send level of the channel to the Stereo Aux. The button beneath controls the channel mute in the Stereo Aux.

3. **Stereo Aux Pan.** The encoder controls the pan position of the channel in the Stereo Aux.
4. **Mono Matrix.** The encoder controls the send level of the channel to the Mono Matrix Mix. The button beneath controls the channel mute in the Mono Matrix Mix.
5. **Subgroup.** If a FlexMix is configured as a mono Subgroup, its screen will be blank. Stereo Subgroups will be provided with a secondary Pan control to right of the blank screen.
6. **Stereo Matrix.** The encoder controls the send level of the channel to the Stereo Matrix Mix. The button beneath controls the channel mute in the Stereo Matrix Mix.
7. **Stereo Matrix Pan.** The encoder controls the pan position of the channel in the Stereo Matrix Mix.

While Aux Sends Mode is engaged, the Touchscreen displays the Aux Sends Overview screen. This screen displays the send level of the Selected channel in every FlexMix:

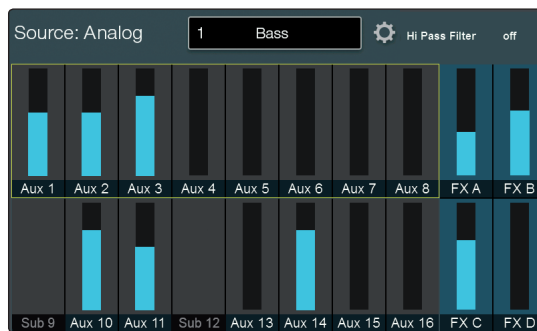

5.1.6 User Mode



The User Mode allows you to create your own custom Fat Channel controls. To assign a function to an encoder and its adjacent button, press any unassigned button. This will open the User Mode edit screen:

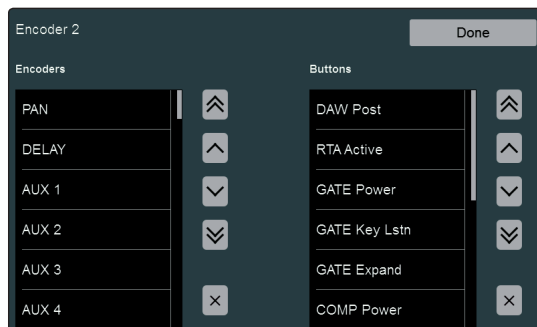

When you are done assigning function, press the Done button on the Touchscreen. To edit any function, press and hold any Fat Channel function button while User mode is active.

5.2 Fat Channel Meters

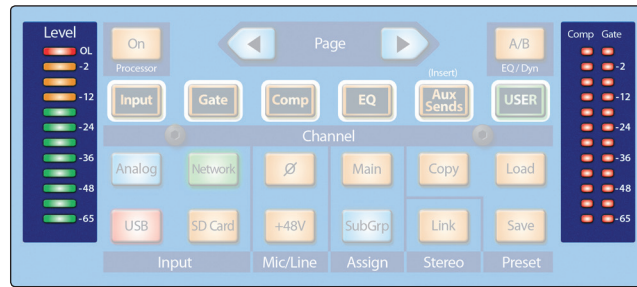

On the left side of the Fat Channel control section, you'll see the "Level" meter. This meter gives you a visual indication of input signal level for the selected channel or mix. On the right side, you'll see meters that pertain to dynamics processing: "Comp" shows compressor gain reduction, and "Gate" shows gate gain reduction.

5.3 Input Source Selection

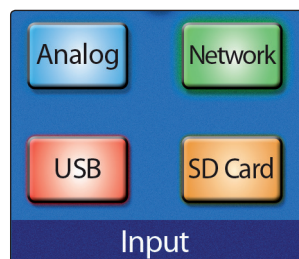

When a channel is selected (rather than a bus or output), these four buttons give you a choice of input type to be routed to that channel. Choose from the following:

- **Analog.** Signal is routed from the corresponding analog input.
- **Network.** Signal is routed from the corresponding channel from the AVB network input (if applicable).
- **USB.** Signal is routed from the corresponding USB audio channel, for playback from a computer.
- **SD Card.** Signal is routed from the corresponding channel of the currently loaded multitrack recording on an inserted SD card.

By pressing and holding any of these buttons, you'll enter Multi-Assign mode, which allows you to set the input source for multiple channels at once. Once in this mode, the Select button for every Input Channel will flash. Press the Select button for any channel for you which you'd like to set to that source. For example, if you would like to engage the USB return for every Input Channel, press and hold the USB Input Source button, then press the Select button for every Input Channel. This will engage the corresponding USB Return for every channel.

5.4 Mic/Line Channel Buttons

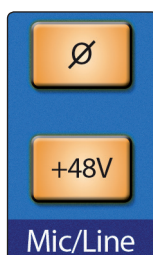

When an analog input channel is selected, these buttons let you toggle channel polarity flipping (Ø) and phantom power (+48V) on or off.

Power User Tip: When recording with more than one open microphone, use the polarity invert to combat phase cancellation between microphones.

5.5 Output Assignment Buttons



When an input channel is selected, you can use these buttons to assign it to an output path. Press **Main** to send the selected channel output to the Main bus. Press **SubGrp** to send the channel output to a subgroup.

You can assign a channel output to a subgroup in two different ways:

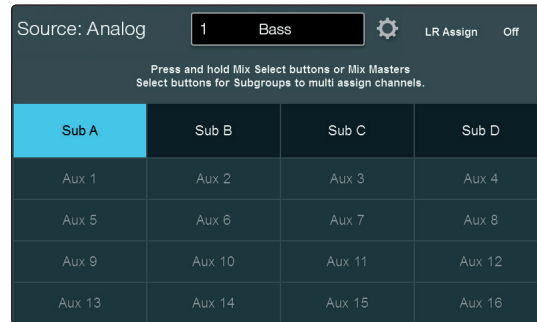

Press the **Subgroup** button and release it, the Subgroup Assignment view shows in the touchscreen, with a list of all available subgroups. You can then touch the desired subgroup to route the channel to the subgroup of your choice.

To quickly assign a channel to multiple FlexMix Subgroups at once:

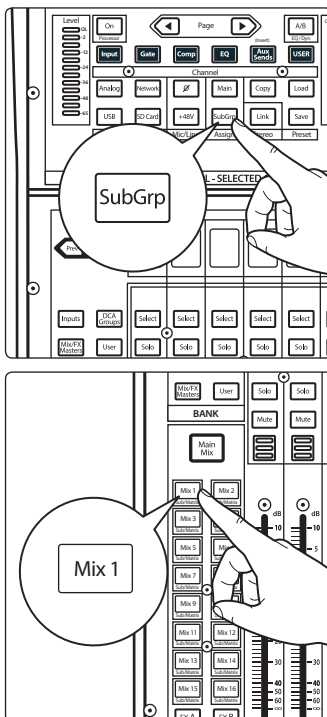

1. While the channel is selected, press and hold the **SubGrp** button in the Assign section of the Fat Channel.
2. The available subgroup FlexMix select buttons will flash. Press the **FlexMix** select buttons for the subgroups to which you'd like to assign the channel.

5.6 A/B Comparison for EQ and Dynamics Settings

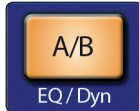

The A/B button lets you make A/B comparisons of EQ, compressor, and gate settings for the selected channel or mix. This function lets you try various changes as you look for the optimum setting, without the risk of losing your original settings. If this button is dimmed, you're looking at the "A" set of parameter settings. If this button is lit fully, you're looking at the "B" parameter set.

To A/B Fat Channel settings, press the A/B button. This saves the current EQ and dynamics settings for the selected channel as the "A" snapshot, and copies its settings to a second snapshot, we'll call "B." The A/B button lights, to tell you that you are now working with the "B" snapshot.

Power User Tip: The A/B function can also be used to maintain two distinct Fat Channel settings for a given. So, the next time the guitar player tells you that they plan to switch to a hollowbody mid-show, you can be ready with a more appropriate alternate setting, saved as the "B" snapshot.

5.7 Stereo Link



When a channel or mix is selected, pressing this button links some of the parameters of a channel or mix with those of its even or odd counterpart (channel 1 links only with 2, 7 links with 8, and so on). When this button is lit, the selected channel is linked to its paired channel. The following parameters are always kept in parity between linked channels or buses:

- Input assignment
- Channel type
- Bus mode (aux/subgroup)
- Compressor/EQ type
- Gate parameters & keying (signal from either channel or mix can trigger both related gates)
- EQ parameters
- Graphic EQ settings
- Mute and Solo states
- Bus assignments
- Phantom power and polarity status
- Fat Channel EQ/Dyn A/B status
- Aux and FX send levels
- Pan position
- Filter DCA group assignment
- Talkback and monitor routing settings
- Pre/post fader settings
- Bus output delay

Some parameters have configurable linking behavior that allow them to work in tandem (stereo linked) or be independently set. This is configured in the Channel Settings screen in the Master Control section:

- Preamp trim
- Pan settings
- Channel or mix fader levels
- Compressor and limiter keying
- Channel/bus names

For more information on selecting linking options, *see Section 5.1.1.1.*

5.8 Copy/Paste & Preset Load/Save



Press **Copy** to copy Fat Channel settings from the currently selected channel to one or more other channels. Once Copy is pressed, the Select buttons for all other channels start blinking. Press the **Select** button on any channels to which you want to copy Fat Channel settings from the currently selected channel.



Press **Load** to paste the settings to the selected channels.



The **Save** and **Load** buttons let you save and load Fat Channel presets, letting you store and reapply useful Fat Channel processing and utility settings to future mixes. While all Fat Channel settings are included when you save a preset, you can choose to filter out some types of settings, to load only part of a preset (such as only EQ and compressor parameters).

To save a preset:

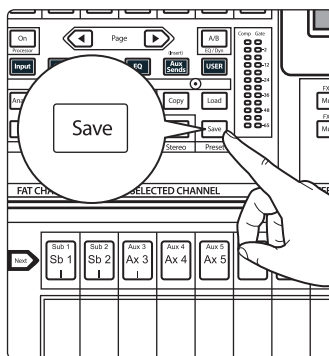

1. Press **Save**. The Fat Channel Presets view is shown on the touchscreen.

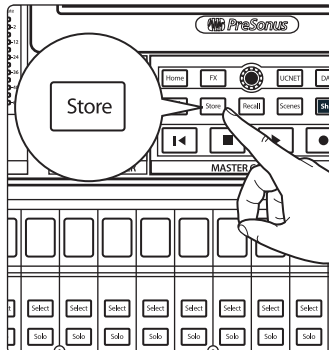

2. Press the **Store** button in the Master Control area to bring up the onscreen keyboard. Enter your preset name with the keyboard, and choose a category (such as Kick Drum or Guitar) from the Category selector, if desired.
3. Press the **Enter** button on the keyboard to save your preset, or press the **back-arrow** to cancel and exit this screen.

To load a preset:

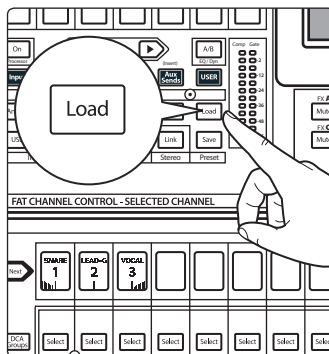

1. Press **Load**. The Fat Channel Presets view is shown on the touchscreen.

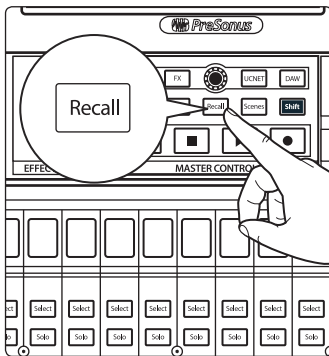
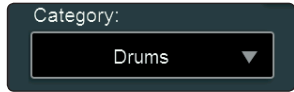
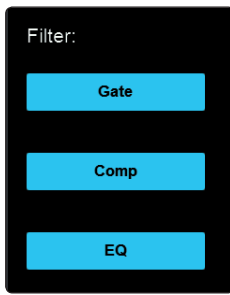

2. To partially load a preset (say, EQ parameters only), press the relevant buttons in the Filter column to disable loading for one or more processors.

3. To filter the presets by channel category (such as Kick Drum or Guitar), make a selection from the Category selector.

4. Select a preset and load it by pressing the **Recall** button in the Master Control area.

You can also momentarily audition the effects of a preset by selecting a preset and pressing the **Audition** button on the touchscreen, or rename it by pressing **Rename** and entering a new name with the onscreen keyboard.

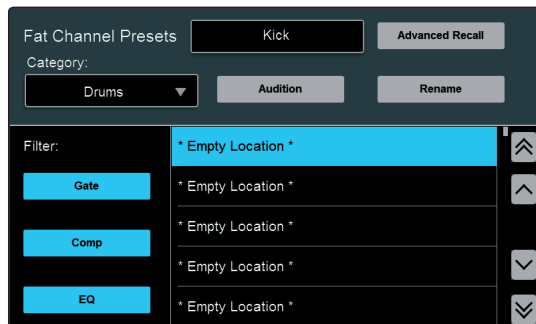

If you need finer control of which Fat Channel settings are included when copy/pasting or loading presets, press **Advanced Recall** to open the Copy/Paste & Preset Filtering screen. In this screen you can set the exact parameter types that are included in each of these two preset actions. Click **Copy/Paste** and press the desired parameter buttons to filter parameters for copy/paste actions. Click **Preset Load** to do the same for preset loading actions.

6 Tape Controls



By default, the Tape channel is sourced from the analog Tape In jacks on the rear of the mixer and the currently paired Bluetooth audio device simultaneously. The two signals are mixed together and summed on the Tape In channel.

If you prefer, you can instead route audio from a connected network device, computer connected via USB, or from audio files stored on an inserted SD card.

To configure the tape input options, press the **Edit** button in the Tape control area, next to the touchscreen.

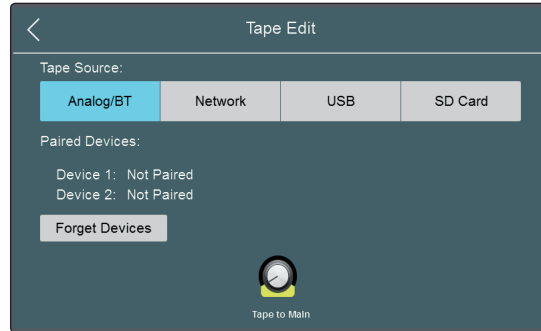

The Tape Edit screen is displayed. Here, you can choose a signal to be routed to the Tape input channel from the following options:

- **Analog/BT.** Touch this button to route both the Tape input jacks and the currently selected paired Bluetooth device to the Tape input channel. When selected, two slots are shown for paired Bluetooth devices. Touch the button that relates to your choice of device to route its audio output to the Tape input channel. Each device also has a Remove Device button, which lets you break the pairing connection to that device, allowing you to pair another device, or to work out pairing issues with a device that doesn't seem to function.
- **Network.** Touch this button to use audio from the designated network tape channels (37 and 38) as the local tape input source. For more information *see Section 8.1.4.*
- **USB.** Touch this button to route audio from a USB-connected computer to the Tape input channel. Once selected, USB streams 37 and 38 will be available as the tape source. For more information on USB audio routing, *see Section 8.1.4.*
- **SD Card.** Touch this button to route audio residing on an inserted SD card to the Tape input channel.

The Tape to Main knob mirrors the setting of the Tape input channel fader. Touch the knob to adjust this setting with the Master Control encoder.

6.1 Pairing a Bluetooth Device

To pair a Bluetooth audio device for use with the Tape input:

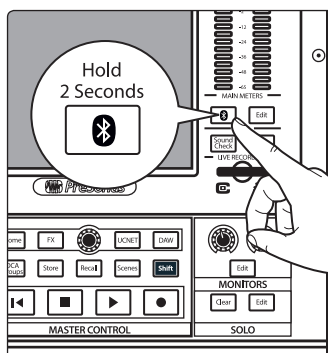

- Press and hold the **Bluetooth** button in the Tape control area for two seconds to enter pairing mode.
- The button will flash, indicating that your StudioLive is searching for a discoverable Bluetooth device.
- Once your device is successfully paired, the Bluetooth button will illuminate and stop flashing.

Note that while up to two Bluetooth devices can be paired at one time, only one device can input audio at a time.

7 SD Recording



Your StudioLive mixer has audio recording and playback abilities that can come in very handy, especially in a live sound context. You can record multi-track live performances to an SD card for later use. Also, you can play back multi-track audio from previously recorded performances, for use as a “virtual sound check,” allowing you to dial in your mix even when the band isn’t around.

To begin the process of recording or playing back a performance, press the **Edit** button in the Live Recording control section, which brings up the Live Recording Edit screen on the touchscreen.

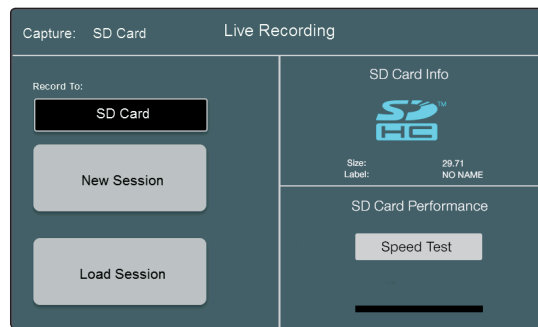

This screen is the starting point for recording or playing back a live performance on an SD card and allows you to create new sessions, load saved sessions from your SD/SDHC card, and test your SD/SDHC card’s speed.

Before beginning any multitrack recording, it is recommended that you format your SD/SDHC card in FAT32 format, even if your card was formatted prior to being packaged. There are several utilities that allow you to format your SD/SDHC card.

Please note: The StudioLive Series III mixers support both SD and SDHC cards up to 32 GB. Tested and approved models and brands can be found at www.PreSonus.com.

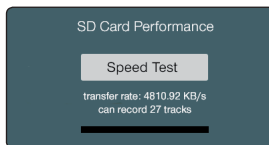

The first time you insert your SD/SDHC card, you should perform a Speed Test. This simple test can take several minutes, depending on card speed, and will tell you the transfer rate of your card, as well as the amount of simultaneous tracks you can reliably record.

Power User Tip: Your StudioLive is also equipped with a USB audio interface to record and play back from a computer. For more information about recording on a computer, **please review the StudioLive Software Library Reference Manual.**

7.1 Creating a New Session for Recording

When the Live Performance Edit screen is displayed on the touchscreen, you can create a new live recording Session by touching New Session on the touchscreen. This brings up the **New Session** screen.

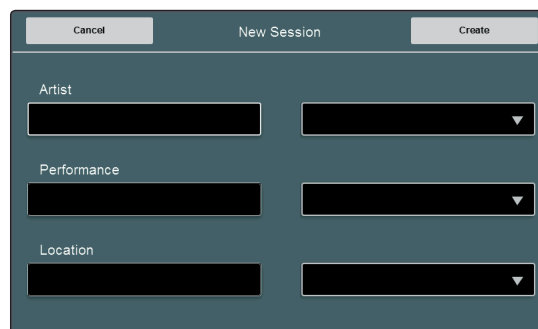

In this screen, you can enter the artist’s name, a name for the performance (venue, date, etc.), and the location of the performance, to help you keep track of various live recordings. If you touch the **Artist**, **Performance**, or **Location** field on the touchscreen, an onscreen keyboard is shown, to let you enter the required information.

When you've entered the artist name, performance name, or location for one Session, it is saved for easy use in future sessions (up to 10 of each category at a time). Saved designators can be easily selected by touching the drop-down menus in the right column of controls on this page. Use the Master Control encoder to scroll through choices.

Once you've entered the needed information for your new Session, touch **Create** in the touchscreen to create the new session, or touch **Cancel** to cancel this operation and exit the New Session screen. Once a new Session is created, the Capture screen is displayed on the touch screen, and you can begin recording. For more information, see [Section 7.3](#).

7.2 Loading a Session for Playback

When the Live Performance Edit screen is displayed on the touchscreen, you can load a previously recorded Session for playback or Virtual Soundcheck, by touching **Load Session** on the touchscreen. This brings up the Load Session screen.

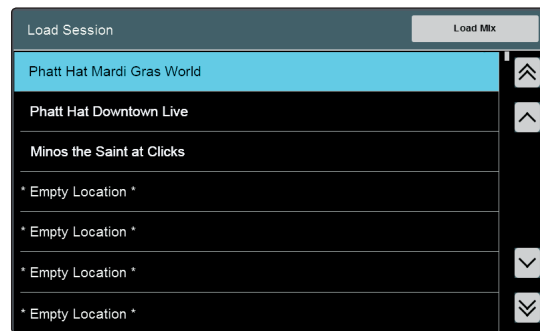

In this screen, you can select from a list of existing live recording Sessions on the currently selected playback medium. Scrolling buttons on the right side of the touchscreen let you scroll through the available options.

To load a session for playback:

- Touch the Session of your choice to select it. The **Recall** button flashes.
- Press **Recall** to load the Session.
- Once the Session is loaded, the Capture screen is shown, and you can begin playback of your Session.

When the Load Mix button is active, the mix Scene stored with the session will also load. The parameters that are loaded are filtered according to the settings in the Scenes screen. For more information on creating and recalling mixer scenes, see [Section 8.5.3](#).

7.3 Capture Screen

PreSonus Capture is a multitrack digital-audio recording application designed to make recording with StudioLive mixers quick and easy. This application is built into StudioLive Series III mixers, allowing you to track directly to an SD card using the same high-quality audio engine as PreSonus' groundbreaking Studio One DAW. Session files recorded on the SD Card can be opened directly in Studio One and Capture – no conversion or exporting necessary.

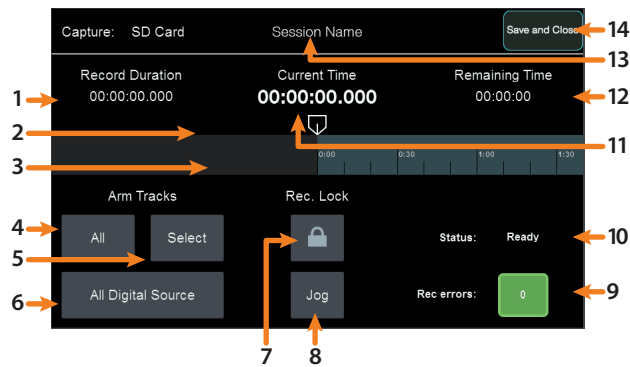

1. **Record Duration.** Shows the total recorded length of the current Session.
2. **Current Position.** Shows the current position of the recording and playback.
3. **Timeline.** Shows the current cursor location in the timeline of the current Session, along with any Markers that you've placed.
4. **Arm All Tracks.** Touching this button will arm all 38 tracks for recording. This will record all 32 input channels, both stereo Aux Inputs, and your Main mix.
5. **Select Arm Tracks.** Press the Select button to enable channel selection mode. In this mode, you can press the Select buttons on each channel in the mixer to arm specific channels for recording. When a channel is selected, its Select button glows steadily. When a channel is not selected, the button flashes.
6. **All Digital Source.** Touch this button to route audio from the Capture Session to the input channels. Touch this button again to go back to the previously established routing.
7. **Recording Lock.** Touch this button to enable Recording Lock mode. When this mode is enabled, recording cannot be stopped by pressing the Stop button in the Transport controls. To disable this mode, touch the lock button again.
8. **Jog.** Touch this button to use the Master Control encoder as a jog-wheel, to move the recording/playback cursor.
9. **Rec. Errors.** This field indicates the number of errors and the potential for errors to occur. *See Section 7.3.1* for more information.
10. **Status.** Displays the current recording status. *See Section 7.3.1* for details.
11. **Current Timeline Position.** Displays the current playback and recording position.
12. **Remaining Time.** Shows the amount of time available for recording on the connected recording medium
13. **Session Name.** Displays the name of the current Session.
14. **Save and Close.** Saves the session and returns to the Live Recording Edit screen.

7.3.1 Recording Status Messages

The following indicators on the Capture screen will help you to keep an eye on how well your recording session is going:

Status:

Status: Ready

- **Ready.** SD Card session is loaded, is currently not busy, and is waiting for user input.

Status: Recording

- **Recording.** Audio is being recorded to any Track(s) that are currently armed for recording.

Status: Preparing...

- **Preparing...** The session currently processing an action. This is commonly seen when attempting to play back a long session after it is first loaded or has just finished recording.

Status: Playing

- **Playing.** The recorded session audio is currently being played back.

Rec Errors:

Rec errors: 0

- **Green.** The recording session currently has no recording errors and there isn't a chance that an error will occur. The green box will display 0 inside, showing that there are currently no record errors.

Rec errors: 0

- **Yellow.** The recording session currently has no record errors, however the SD Card's read/write speed are being stretched to the limit. In this case, it is possible that recording errors can occur. The yellow box will display 0 inside, showing that there are currently no record errors.

Note: As an SD Card's storage space is filled, its read/write speed slows down. Because of this, the Rec Errors indication may turn from green to yellow as the card fills up.

Rec errors: 1

- **Red Square.** As soon as a recording error occurs, this indication will turn red to alert you. The number of errors will be displayed in the box. When errors occur, you will hear a skip or a drop-out in the recorded audio.

Power User Tip: As soon as you see an error display, make a note of the current timeline position. This will help you to isolate the audio dropout more easily.

7.3.2 Transport Controls

When a new Session is created or an existing Session is loaded, the Transport buttons give you control over recording, playback, and navigation through the timeline of the current Session. Use these controls in conjunction with those in the Capture screen for total control of your recording and playback needs. The button functions are as follows:

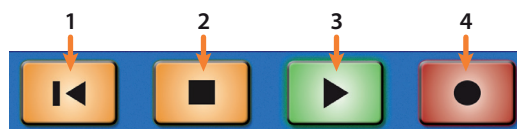

1. **Return to Zero.** Press this button to move the recording/playback cursor to the start of the Session timeline. Enable Shift and press Return to Zero for Rewind.
2. **Stop.** Press this button to stop playback or recording.
3. **Play.** Press this button to begin playback from the current cursor position in the Session timeline. Enable Shift and press Play for Fast Forward.
4. **Record.** Press this button to begin recording from the current cursor position in the Session timeline.

7.4 Sound Check Button

We've all been there. The drummer is stuck in traffic. The guitarist is stuck at work. And you're stuck at front-of-house (FOH) with a hyped up lead singer and bass player and no way to dial in a front-of-house mix, let alone set up the singer's in-ear mix. Don't panic! With Capture's Virtual Soundcheck mode, dialing a good rough mix without the band—or with half the band missing—is quick and simple.



1. To begin, create a new Session, press the Soundcheck button on your StudioLive mixer.
2. This will launch the Load Session screen. Select the previously recorded session you would like to use for your Virtual Soundcheck.

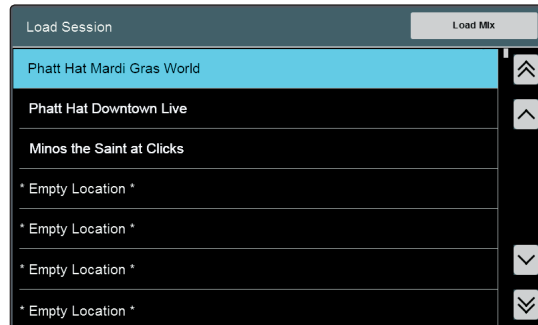

3. The Recall button will begin to flash. Press the Recall button to load the saved Session. This will also engage all the SD channel returns.



4. Your mixer scene is automatically saved with your Capture session. Enabling the Load Mix function will load the saved StudioLive mix scene as well.
5. Use the **Transport controls** to playback the recorded audio and dial in your mix.



6. When you have finished setting up your mix, press the Soundcheck button again to exit. This will close the Capture session and disengage all the SD returns on your StudioLive, leaving the track labels on your mixer.

8 Master Control



The Master Control area contains the all-important touchscreen and an array of controls that give you access to vital functions of the mixer (such as FX, networking, DAW interactions, and so on). The following section details the use of these controls and the features they bring.

8.1 Home Button Features



When you press the Home button, the Home screen is displayed on the touchscreen. This screen gives you access to settings and functions related to system configuration and troubleshooting.

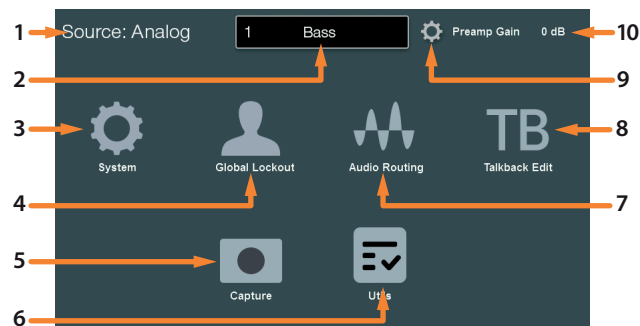

1. **Channel Source.** Displays currently selected channel's input source.
2. **Selected Channel.** Displays currently selected channel or bus.
3. **System.** Lets you adjust the display brightness, and a host of other useful settings and utilities. For more information, *see Section 8.1.1*.
4. **Global Lockout.** Lets you create a passcode to globally lock your mixer functions. For more information, *see Section 8.1.2*.
5. **Capture.** Lets you record and play back multi-track audio, recorded to SD card or a connected computer. For more information, *see Section 7.4*.
6. **Utils.** Lets you run a variety of tests, to help locate hardware faults in the occasion of a problem. For more information, *see Section 8.1.3*.
7. **Audio Routing.** Lets you configure audio signal routing for networked audio devices, SD card/USB audio, and signals from compatible AVB networkable devices. For more information, *see Section 8.1.4*.
8. **Talkback Edit.** Opens the Talkback Edit page. For more information, *see Section 4.9.1*
9. **Settings.** Opens the Channel or Bus Settings screen. For more information, *see Section 5.1.1.1*.
10. **Current Parameter.** Displays current parameter.

8.1.1 System Screen

The System screen gives you access to many useful settings and functions that let you choose how your StudioLive looks and operates. The following functions are available:

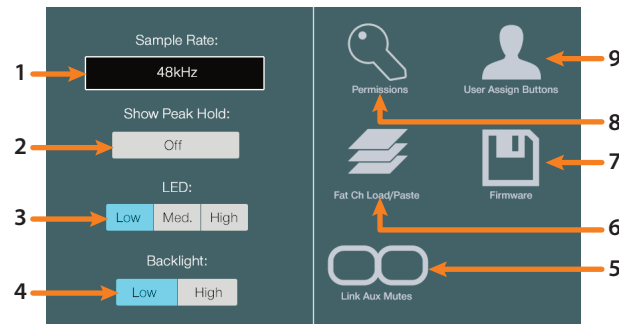

1. **Sample Rate.** Displays the mixer's sample rate. StudioLive Series III mixers have a fixed sample rate of 48 kHz.
2. **Show Peak Hold.** Toggle this option on to enable peak hold mode for the various meters throughout StudioLive. When enabled, an indicator segment is lit on each meter, showing the highest point in the amplitude scale that the related signal has reached.
3. **LED Brightness.** Gives you a range of brightness settings for the LEDs. Choose Low, Mid, or High brightness for each.
4. **Backlight Brightness.** Sets the brightness for the scribble-strip displays and touchscreen. Choose between Low or High
5. **Link Aux Mutes.** Lets you select a mode of operation for linking mute buttons between channels and aux sends. For more information, *see Section 8.1.1.5.*
6. **Fat Channel Load/Paste Filters.** Lets you choose which parameters are included when you load a Fat Channel preset or copy/paste Fat Channel settings between channels. For more information, *see Section 8.1.1.3.*
7. **Firmware.** Shows the currently installed version of the StudioLive firmware, and offers functions for installing firmware updates. For more information, *see Section 8.1.1.4.*
8. **Permissions.** Lets you configure StudioLive control permissions for any connected compatible controllers. For more information, *see Section 8.1.1.1.*
9. **User Button Assigns (StudioLive 32 and 24 only).** Lets you set the functions of the User Buttons. For more information, *see Section 8.1.1.2.*

8.1.1.1 Permissions

Controlling your StudioLive remotely with UC Surface or QMix-UC for mobile devices allows you to move about the venue freely. However, it can also put the full power of your mixer in multiple hands— some more adept than others. Therefore, your StudioLive enables you to limit each wireless device's access to the mixer features by setting permissions.



From the System menu press the Permissions button to set the level of control available to each user. At the top of the screen is a Device/User selector, which lets you choose which of the connected devices for which to set control permissions. Depending on the type of device you choose (QMix-UC or UC Surface), the screen shows different options:

QMix-UC Device Permissions

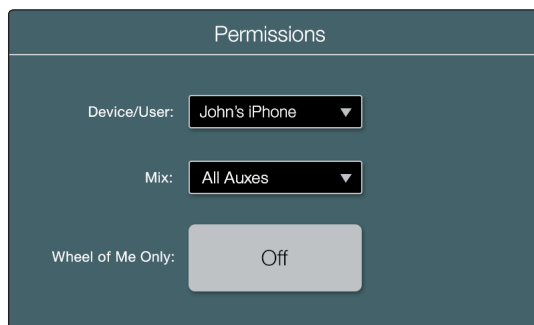

When setting permissions for a device running QMix-UC software, the Mix selector gives you the following modes of control permission to choose from:

- **None.** Select this to disable remote control on the selected device.
- **All Auxes.** Control of every Aux Mix Send level and pan setting.
- **Aux X.** Control of an individual Aux Send level and pan setting.
- **Wheel of Me Only Toggle.** Limits access to the Wheel of Me control only.

UC Surface Device Permissions

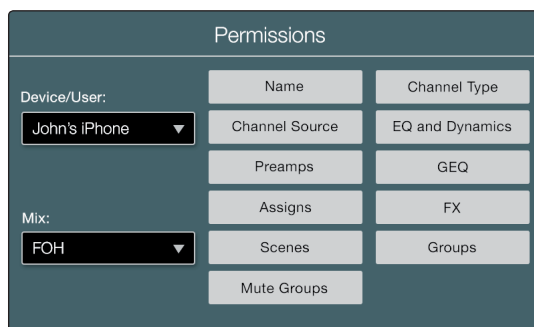

When setting permissions for UC Surface, you can choose to filter out certain functions. When the button is the off state, the function will not be available for the selected device.

The following functions can be disabled individually:

- **Names.** Enables/disables the ability to remotely change channel and bus names.
- **Channel Types.** Enables/disables the ability to remotely change the channel type.
- **Channel Source.** Enables/disables the ability to remotely change the channel source.
- **EQ & Dynamics.** Enables/disables the ability to remotely change EQ and Dynamics settings for channels and available buses.
- **Preamps.** Enables/disables the ability to remotely control the preamp functions.
- **GEQ.** Enables/disables the ability to adjust the GEQ for the available buses.
- **Assigns.** Enables/disables the ability to assign and unassign channels to the main and subgroup buses.
- **FX.** Enables/disables the ability to edit the effects remotely.
- **Scenes.** Enables/disables the ability to remotely change scenes.
- **Groups.** Enables/disables the ability to remotely create Filter DCA groups.
- **Mute Groups.** Enables/disables the ability to remotely control mute groups.

8.1.1.2 User Buttons Assigns (StudioLive 32 and 24 Only)

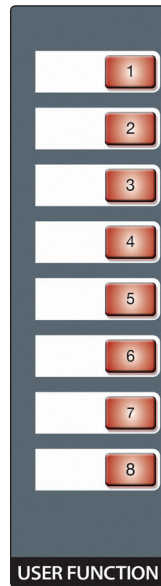

The StudioLive 32 and 24 feature eight user-assignable buttons. These buttons can control the following functions: Mute Groups 1-8, Tap Tempo A-D, Quick Scenes 1-8, Scene Navigation, or DAW Navigation. By default, these buttons are assigned to Mute Groups 1-8.



From the System menu, touch the **User Assign** button to set custom functions to the User Buttons. When you first see this screen, you see the current assignments of each User Button, each with its own Edit button:

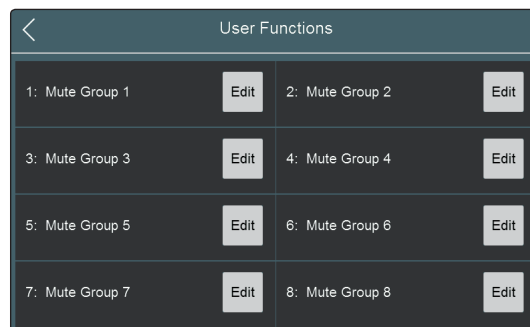

Press the **Edit** button that corresponds to the User Button you want to edit, and you'll see a function assignment screen.

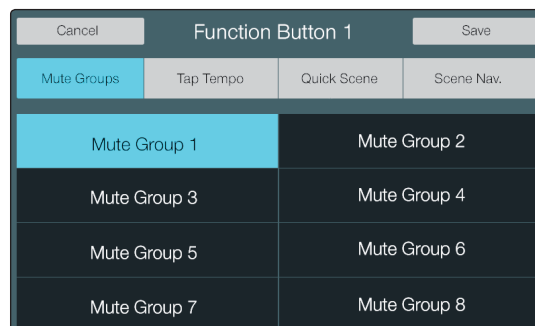

In this screen, you can choose the function to assign to the chosen button, in the following categories:

- **Mute Groups.** Lets you create stored sets of mute settings that correspond with the current state of the mixer, recallable at the press of the chosen User Button. Once a User Button is configured as a Mute Group, you can edit the Mute Group by pressing and holding the User Button until it begins to flash. This will store the currently active mutes to the selected Mute Group.
- **Tap Tempo.** Lets you assign the chosen User Button to act as a tap tempo button for any delay effects currently assigned to FX bus A-D. Only FX buses with a delay effect assigned are shown.
- **Quick Scene.** Lets you create stored sets of mixer settings that correspond with the current state of the mixer, recallable at the press of the chosen User Button. Once a User Button is configured as a Quick Scene, you can edit it by pressing and holding the User Button until it begins to flash. This will store the current state of the mixer to the selected Quick Scene.
- **Scene Navigation.** Lets you assign a Scene navigation function to the current User Button. The options include Previous Scene, Next Scene, Scene Recall, and Store Scene.
- **DAW Navigation.** Lets you assign a DAW mixer navigation function to the current User Button. The options include next channel (DAW Bank >), previous channel (DAW Bank <), next bank (DAW Bank >>), and previous bank (DAW Bank <<).

8.1.1.3 Fat Channel Load/Paste



To choose which types of Fat Channel parameter settings are applied when you load a Fat Channel preset or copy and paste Fat Channel settings between channels, touch the **Fat Channel Load/Paste** button from the System menu.

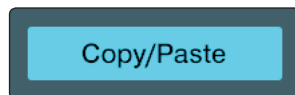

Touch **Copy/Paste** to set copy/paste filter settings.

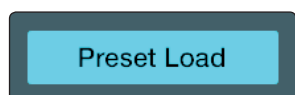

Touch **Preset Load** to set preset loading filter settings.

The following categories of settings are available to toggle on or off:

- Preamp. (Filtered by default)
- +48V. (Filtered by default)
- Polarity. (Filtered by default)
- Pan.
- Channel Type.
- Channel Name.
- Alt A/B Settings.
- Bus Assignments. (Filtered by default)
- Aux/FX Send/Pan. (Filtered by default)
- Mutes. (Filtered by default)
- Faders. (Filtered by default)

8.1.1.4 Firmware Update



From the System menu, you can check the current firmware version and check for firmware updates by pressing the **Firmware** button.



Press the **Check for Updates** button to check for a new firmware version, which may be on an SD card, the internet (when connected), or a connected UC Surface device. If a new version is available, you can then touch **Update** to complete the firmware update, or press **Cancel** to cancel the update.

8.1.1.5 Link Aux Mutes



Pressing the **Link Aux Mutes** button from the System menu lets you select between four linking modes that choose the way channel mutes and Aux send mutes interact:

- **Unlinked.** When this mode is selected, channel mutes can be independently controlled in each Aux Mix and the Main Mix.
- **Main Mute Auxes.** When this mode is selected, muting a channel in the main mix will mute it in every aux mix. However, channels can be muted and unmuted independently from each aux mix.
- **All Aux Mute Link.** When this mode is select, the channel mutes for every aux mix are linked. In this mode, muting a channel from any aux mix will mute it in every aux mix but not in the Main mix.
- **Global Mute Link.** When this mode is select, the channel mutes for every aux mix and the Main mix are linked. In this mode, muting a channel from any mix will mute it in every mix.

8.1.2 Global Lockout



The StudioLive features a Lockout mode that allows you to lock the controls. This is especially useful in situations where you have to step away from the console and are concerned about curious audience members or band members making modifications to your mix.

Pressing the Global Lockout button from the Home screen will lock your mixer.

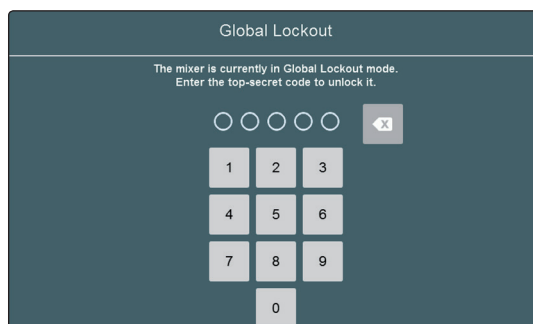

Enter 1-2-3-4-5 to unlock your mixer.

8.1.3 Utilities

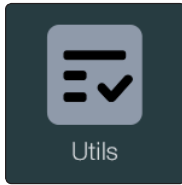

Your StudioLive is equipped with a variety of utilities that allow you to test the functionality of your mixer. Pressing the **Utility** button from the Home screen will open this menu.

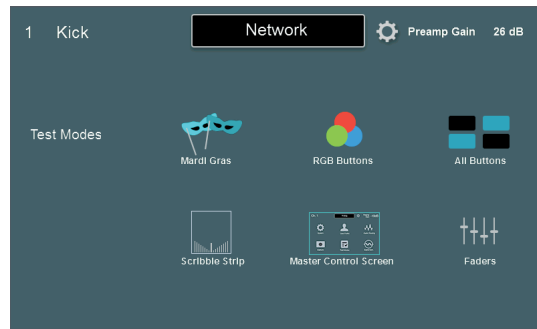

The following test modes are available:

- **Mardi Gras.** Causes all faders, LEDs, and displays to cycle through their ranges of motion, color, and brightness.
- **Meters and Button LEDs.** Causes all meters and button LEDs to cycle through their ranges of color and brightness.
- **RGB Buttons.** Causes all color-changing buttons to cycle through their ranges of color and brightness.
- **Scribble Strip.** Causes all scribble strip displays to cycle through a range of color test patterns.
- **Master Control Screen.** Causes the touchscreen to cycle through a range of color test patterns.
- **Faders.** Causes the faders to cycle through their range of motion. Move the Main fader to cycle all faders through various test modes (all at top, all at bottom, diagonal, and pattern movements).

When you are done with a particular test mode, press anywhere on the touchscreen to return to the Test Modes screen.

8.1.4 Audio Routing



Pressing the **Audio Routing** button in the Home screen will give you access to audio routing options for networked audio devices, USB sources, SD card recordings, and special settings for networked PreSonus devices.

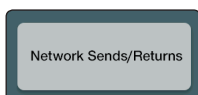

Touch the **Network Sends/Return** button to route audio to and from the last 16 AVB Network Sends and Returns to and from the StudioLive Mix outputs. *See Sections 8.1.4.1 and 8.1.4.2* for more information.

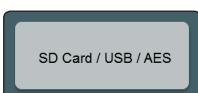

Touch **SD Card/USB/AES** to select which mixes are routed to the last two USB and SD channels as well as the AES output. *See Section 8.1.4.3* for more information.

8.1.4.1 Network Sends

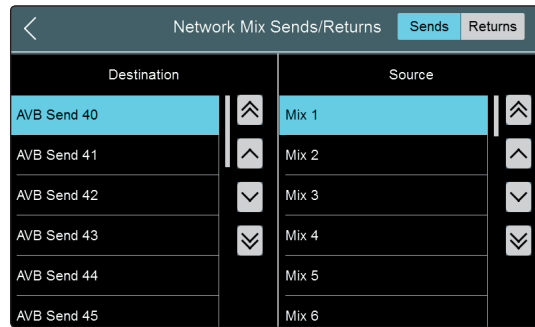

This screen lets you route any of the 16 FlexMix outputs as well as the 4 Subgroups, Main L/R, Solo L/R, and FX Sends A-D to any one of the last 16 AVB Network sends. Press the arrow buttons to either side of the list to scroll through the list, and touch the Mix Output and desired AVB Send to make the routing.

8.1.4.2 Network Returns

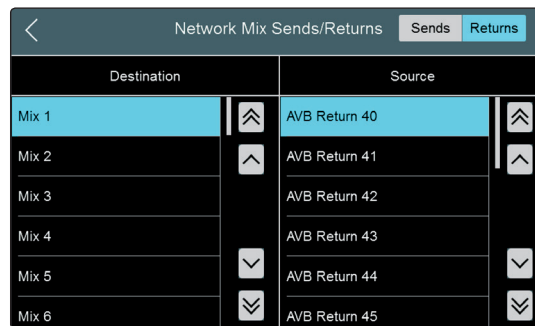

This screen lets you route any of the last 16 AVB Network Returns to any of 16 FlexMix outputs as well as the 4 Subgroups, Main L/R, Solo L/R, and FX Sends A-D. Press the arrow buttons to either side of the list to scroll through the list, and touch the Mix Output and desired AVB Send to make the routing.

8.1.4.3 USB/SD Card Outputs Screen

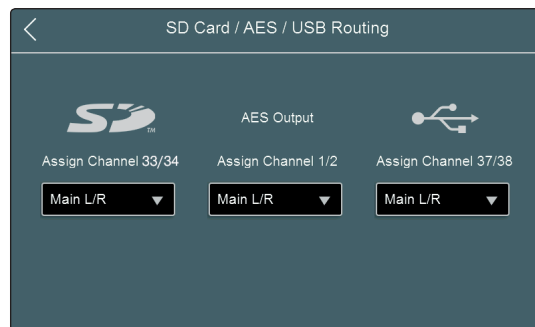

This screen lets you route any of the FlexMixes, Main Mix, or Subgroups to the last pair of channels on the SD and USB recording as well as to the AES output.

- **Main Left/Right Output.** (Selected by default)
- **FlexMix Output** (in pairs).
- **Subgroup Output** (in pairs).

Power User Tip: When recording via USB, these last two USB channels will show up in your recording software labeled as Assignable Inputs.

8.2 FX



The FX button gives you access to a set of screens that let you assign and configure the built-in Send FX and Insert FX processors in your StudioLive. When you first press **FX**, the FX Rack screen appears on the touchscreen.

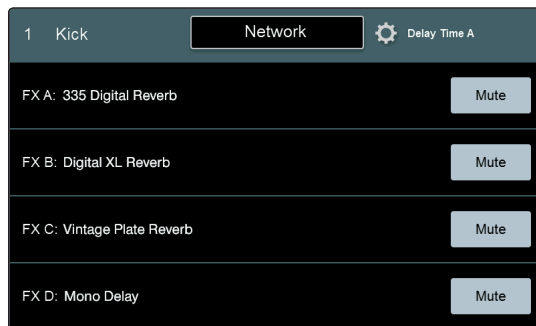

This screen displays the current effect processor inserted on each of the four internal effect buses. From here, you can mute each effect. Touching an effect's name will open the effects editor for that effects slot.

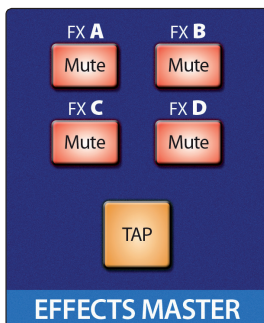

Each of the four effects processors is also equipped with a physical mute button in the Effects Master section on your StudioLive mixer.

A Tap-Tempo button is also provided to control the tempo for any of the delay effects. If you have just one send FX slot occupied by a delay effect, this button will set its tempo. If you have more than one delay effect assigned, you can choose which of the multiple delays are governed by this button in your FX settings. To synchronize a delay effect to music as you hear it, tap this button in rhythm with the music (in 1/4-note, or one-beat intervals), until the delay effect is synced to your liking.

Power User Tip: The Tap button also act as a "null" button for parameters in the Fat Channel, Graphic EQ, and FX processors. Press and hold **Tap** and adjust the control of your choice to return that control to its default setting.

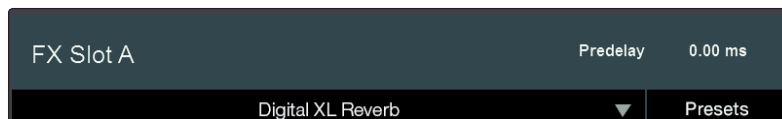

At the top of each effect, you will find the effects type drop down menu. Tap to change the effects type.

You will also find the presets button. Tap to open the presets screen.

8.2.1 Digital XL Reverb

This convolution-style reverb emulates an acoustic space to add life and vibrancy and provides the following controls:

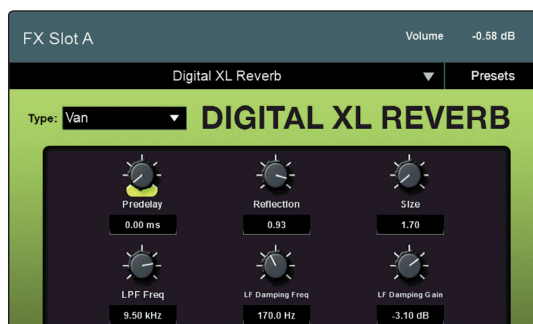

- **Predelay.** Sets the length of short delay before the onset of reverberation, lending a sense of space to the reflections.
- **Reflection.** This control allows you to set the level (in decibels) of the early reflections. The louder the early reflections, the smaller the room will seem.
- **Size.** Sets the width of the stereo image.
- **LPF Frequency.** Use this control to attenuate low frequencies that can muddy a reverb.

- **LF Damping Freq.** Use this control with create a warmer sound. This will enhance content at the frequency you set.
- **LF Damping Gain.** Sets the level at which the damping frequency will be boosted.

8.2.2 335 Digital Reverb

This reverb mimics the controls and sound of classic 1970s digital reverb and provides the following controls:

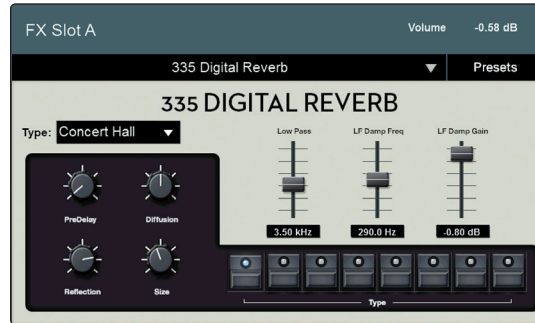

- **Predelay.** Sets the length of short delay before the onset of reverberation, lending a sense of space to the reflections.
- **Diffusion.** Sets the amount of diffusion to apply to the reverb tail.
- **Reflection.** This control allows you to set the level (in decibels) of the early reflections. The louder the early reflections, the smaller the room will seem.
- **Size.** Sets the width of the stereo image.
- **Low Pass.** Use this control to attenuate low frequencies that can muddy a reverb.
- **LF Damp Freq.** Use this control with create a warmer sound. This will enhance content at the frequency you set.
- **LF Damping Gain.** Sets the level at which the damping frequency will be boosted.

8.2.3 PAE-16 Digital Reverb

This reverb effect is inspired by a classic 80's-era digital reverb unit and provides the following controls:



- **Predelay.** Sets the length of short delay before the onset of reverberation, lending a sense of space to the reflections.
- **Diffusion.** Sets the amount of diffusion to apply to the reverb tail.
- **Reflection (Time).** This control allows you to set the level (in decibels) of the early reflections. The louder the early reflections, the smaller the room will seem.
- **Low Pass.** Use this control to attenuate low frequencies that can muddy a reverb.
- **LF Damp Freq.** Use this control with create a warmer sound. This will enhance content at the frequency you set.
- **LF Damping Gain.** Sets the level at which the damping frequency will be boosted.

8.2.4 Vintage Plate Reverb

This reverb effect is inspired by a classic mechanical plate reverb unit and provides the following parameters:



- **Predelay.** Sets the length of short delay before the onset of reverberation, lending a sense of space to the reflections.
- **Reflection.** This control allows you to set the level (in decibels) of the early reflections. The louder the early reflections, the smaller the room will seem.
- **Low Pass.** Use this control to attenuate low frequencies that can muddy a reverb.
- **LF Damp Freq.** Use this control with create a warmer sound. This will enhance content at the frequency you set.
- **LF Damping Gain.** Sets the level at which the damping frequency will be boosted.

8.2.5 Mono Delay

This delay effect offers a simple, quick-to-use multi-tapped delay arrangement and provides the following parameters:

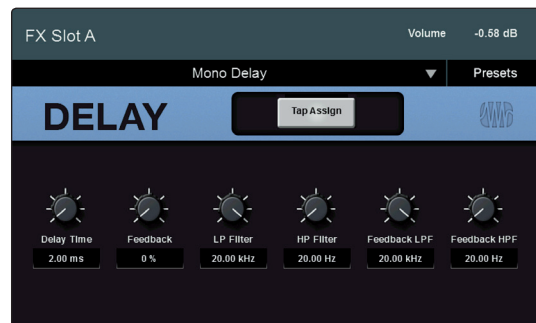

- **Delay Time.** Sets the length of the delay line.
- **Tap Assign.** Assigns the Tap Tempo to the TAP button.
- **Feedback.** Sets the amount of delayed signal to be fed back to the input of the effect. Higher settings lead to longer delay tails (and eventually, outright chaos).
- **LP Filter.** Sets the cutoff frequency for a low-pass filter, applied to the delayed signal.
- **HP Filter.** Sets the cutoff frequency for a high-pass filter, applied to the delayed signal.
- **Feedback LPF.** Sets the cutoff frequency for the low-pass filter applied to the feedback signal.
- **Feedback HPF.** Sets the cutoff frequency for the high-pass filter applied to the feedback signal.

8.2.6 Stereo Delay

This delay effect is inspired by a classic 80's-era dual-delay unit and provides the following controls:



- **Delay Time A and B.** Sets the length of their respective delay line.
- **Tap Assign A and B.** Assigns the respective Tap Tempo function to the TAP button.
- **Feedback A and B.** Sets the amount of delayed signal to be fed back to their respective inputs of the effect. Higher settings lead to longer delay tails (and eventually, outright chaos).
- **Spread.** Sets the width of the stereo image
- **LP Filter.** Sets the cutoff frequency for a low-pass filter, applied to the delayed signal.
- **HP Filter.** Sets the cutoff frequency for a high-pass filter, applied to the delayed signal.
- **Feedback A and B LPF.** Sets the cutoff frequency for the low-pass filter applied to the respective feedback signal.
- **Feedback A and B HPF.** Sets the cutoff frequency for the high-pass filter applied to the respective feedback signal.

8.2.7 Pingpong Delay

As its name indicates, this stereo delay bounces the signal across the stereo field to create a wider image.



- **Tap Assign L and R.** Assigns the respective Tap Tempo function to the TAP button.
- **Time Left and Right.** Sets the delay time for the left and right side, respectively.
- **Width.** Sets the width of the stereo image.
- **Feedback.** Sets the amount of delayed signal fed back into the input of the effect.
- **Fb Time.** Sets the delay offset of the feedback signal.
- **LP Filter.** Sets the cutoff frequency for the low-pass filter applied to the delayed signal.
- **HP Filter.** Sets the cutoff frequency for the high-pass filter applied to the delayed signal.
- **Fb LPF.** Sets the cutoff frequency for the low-pass filter applied to the feedback signal.
- **Fb HPF.** Sets the cutoff frequency for the high-pass filter applied to the feedback signal.

8.3 UCNET



UCNET is a special networking protocol that PreSonus created to enable advanced remote control and audio transmission features between various PreSonus hardware and software products. This includes devices running Studio One, Capture, UC Surface, and QMix-UC software.

Note: For more information on networking configuration and setup for UCNET-compatible products, *please see the StudioLive Software Library Reference Manual.*

8.3.1 IP Address Settings

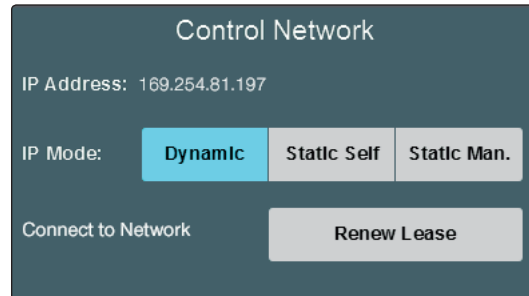

In the Control Network area of the UCNET screen, you'll see the current IP address of your StudioLive. This IP address can be assigned in one of three ways. Select the necessary IP assignment mode by touching one of the following buttons:

- **Dynamic.** The IP address is assigned automatically upon connection to the network, and can shift to a new address when necessary due to changes in network availability. In this mode, a **Renew** button is shown onscreen. Touch this button to renew the DHCP lease for your StudioLive.
- **Static Self (Self-Assigned).** The IP address is assigned automatically, but stays the same thereafter until you need to change it. In this mode, an **Apply** button is shown. Touch this button to auto-assign a new static IP address to your StudioLive.
- **Static Manual.** The IP address can be set manually, and remains the same until it is changed. In this mode, an **Edit** button is shown. Touch this button to open the Static Manual Edit screen, where you can specify IP address, subnet mask, and gateway settings for your StudioLive as needed for your network configuration. Touch each field in the form to bring up an onscreen keyboard for entry. When you're finished entering the settings, press **Apply** to establish the new settings. To exit without re-setting IP settings, touch the **Cancel** button.

8.3.2 Permissions

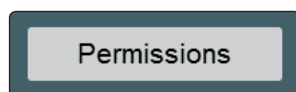

As previously mentioned, some of the mixing functions of your StudioLive can be controlled remotely by networked devices running UC Surface software. For some applications, you may want to limit the degree to which a device can manipulate your StudioLive. To make these choices, touch the **Permissions** button. You can also reach these settings by pressing the **Home** button and navigating to the Settings screen. For more information on setting mixer permissions, *see Section 8.1.1.1.*

8.4 DAW Button



Your StudioLive can act as a control surface for the mixer functions of a computer running our Studio One DAW software. Press the DAW button to switch between normal mixing functions and DAW control. To return to normal operation, press the DAW button again.



While operating in DAW control mode, if there are more channels available in the connected DAW or mixer than there are channel strips on your StudioLive, you can press the **Prev** and **Next** buttons in the Bank section to switch between banks of channels.

Note: At the time of the publication of this manual, DAW control has not yet been implemented. This feature will be added in a future firmware update.

8.5 Scenes

The StudioLive allows you to create and store a library of scenes. A scene is like a snapshot of your mix. It stores each Fat Channel parameter for every input and bus, as well as each fader's position, the aux and effects mixes, channel mutes and solos, and the input selection (analog input or digital playback stream).



To begin working with scenes, press the **Scenes** button. This brings the Scenes screen onto the touchscreen. On this screen, a list of all existing scenes is shown.

8.5.1 S1: Zero Out (Board Reset)

Located at position S1 is a scene named Zero Out (Board Reset). This scene cannot be overwritten and returns each parameter to its default setting. All you have to do is lower all the Monitor bus output volume knobs to their lowest positions. The StudioLive will be zeroed out as follows:

Inputs and Buses	Output Level	Assign	Pan	Solo	Mute	Stereo Link	Aux/FX Sends	Mode
Input Channels	-∞	Mains	C	Off	Off	Off	-∞	n/a
Flex Buses	-∞	n/a	n/a	Off	N/a	Off	n/a	Aux: Pre 1
FXA	Unity	Mains	n/a	n/a	Off	n/a	n/a	Standard Reverb: Post
FXB	Unity	Mains	n/a	n/a	Off	n/a	n/a	Standard Reverb: Post
FXC	Unity	Mains	n/a	n/a	Off	n/a	n/a	Mono Delay: Post
FXD	Unity	Mains	n/a	n/a	Off	n/a	n/a	Mono Delay: Post
Aux In A/B	-∞	Mains	n/a	n/a	n/a	n/a	-∞	n/a
Solo Bus	-∞	n/a	n/a	n/a	n/a	n/a	n/a	AFL
Monitor Bus	-∞	n/a	n/a	n/a	n/a	n/a	n/a	Main
Tape In	-∞	n/a	n/a	n/a	n/a	n/a	-∞	-∞

The Fat Channel will be restored to the same setting for every input and output on the StudioLive. Each of the dynamics processors and the four EQ bands will be turned off.

Their parameters will be set as follows:

Fat Channel Parameters													
CHANNEL		HIPASS	NOISE GATE		LIMIT		COMPRESSOR		EQ	LOW	L.MID	H.MID	HIGH
GAIN	0db	OFF	STATE	OFF	STATE	OFF	THRESH	0 dB	STATE	OFF	OFF	OFF	OFF
PAN	<C>		RANGE	N/A			RAT	2:1	P/S	PEAK	n/a	n/a	PEAK
Source	Analog		ATK	5 ms			ATK	20 ms	Q	0.6	0.6	0.6	0.6
			REL	0.7 ms			REL	150 ms	FREQ	130 Hz	320 Hz	1.4 kHz	5 kHz
			Key Src	Off			GAIN	0 dB	GAIN	0 dB	0 dB	0 dB	0 dB
			Key Fltr	Off			MODE	Standard	MODE	Standard			
			Mode	Expand									

Power User Tip: Before beginning any new mixing situation, we recommended you recall the Zero Out (Board Reset) scene. This is the easiest way to ensure that there are no lingering parameter settings that could cause you some trouble in your new mix.

8.5.2 Nulling Parameters

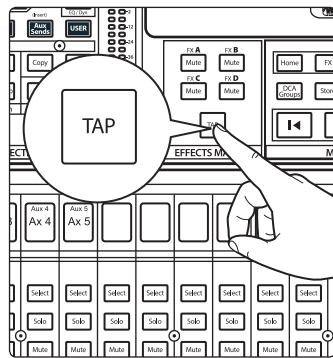

To return any Fat Channel parameter to its Zero Out scene setting, simply press and hold the **Tap Tempo** button and turn its encoder.

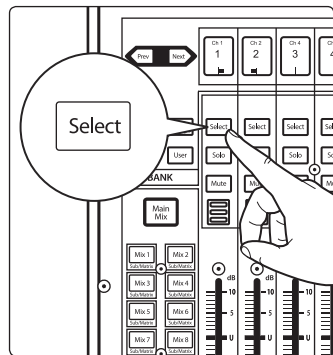

For example, if you want to null the current setting for the Channel 1 pan:

1. Select Channel 1.

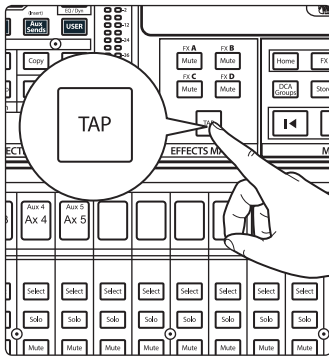

2. Press and hold the **Tap Tempo** button.

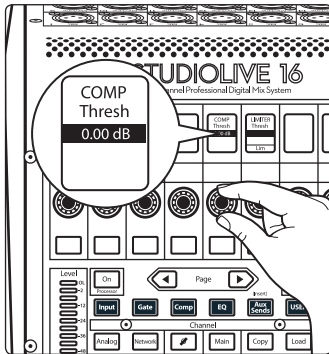

3. Simultaneously turn **Encoder 7: Compressor Threshold** in the Fat Channel. The compressor threshold for Channel 1 will return to its Zero Out setting (0 dB).

8.5.3 Creating and Recalling a Scene

Creating a scene requires simply dialing in a mix that you would like to use at a later date and saving it. This has obvious benefits for both studio and live sound. For example, in the studio, saving and recalling a scene allows you to move to another song or project and come back to the current mix later. For live shows with multiple bands, you can set up custom mixes for each band at soundcheck and recall the mix when that band goes onstage.

You also can save custom mixes for each venue that a band plays repeatedly.

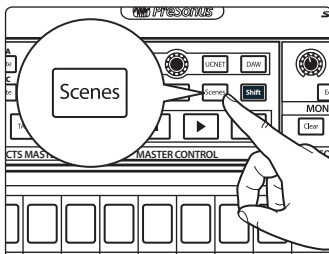

1. To save a scene, press the **Scenes** button.

2. This will open the Scenes library menu in the Touchscreen. The Store and Recall buttons will begin to flash.

Current Scene:		Scene Safe	
* Empty Location *	⬆	Name	PreAmps
* Empty Location *	⬆	FX	GEQ
* Empty Location *		Input EQ/DYN	Output EQ/DYN
* Empty Location *		Aux Mix	Faders
* Empty Location *	⬇	Assigns	+48v
* Empty Location *	⬇	Mutes	DCA Groups

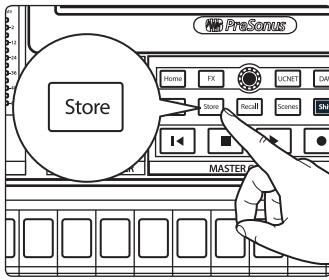

3. Scroll to an empty location and press **Store** to enter a custom name. The StudioLive allows you to customize the name with uppercase and lowercase letters and a selection of numerals and punctuation marks.
4. Press the **Store** button again to save the scene to your mixer's memory.

To recall a scene, touch one of the stored scenes in the library list to select it, then press the **Recall** button to recall the scene.

Name	PreAmps
FX	GEQ
Input EQ/DYN	Output EQ/DYN
Aux Mix	Faders
Assigns	+48v
Mutes	DCA Groups

To the right of this list is a grid of filter buttons. These let you select the parameters you want to be affected when you recall the next scene, from the following list of choices. With the exception of Phantom Power, all filters are enabled by default:

- Name
- Preamps
- FX
- GEQ
- Input EQ/Dyn
- Output EQ/Dyn
- Aux Mix
- Faders
- Assigns
- +48V
- Mutes
- DCA Groups
- Mute Groups



In some cases, you may want to protect a channel or bus from being affected when scenes are recalled. To do this, touch the **Scene Safe** button. This brings the Scene Safe screen to the touchscreen.

This screen shows you a list of all available channels and buses. Touch the channel or bus of your choice to put it into scene safe mode, and protect it from changes when scenes are recalled.

9 Monitoring Controls



In addition to the main outputs, your StudioLive mixer features a set of monitor outputs and a headphone jack, each with its own distinct signal path. While you can use these outputs to listen to the main mix, you can also assign other signals to them, such as Aux mixes, the solo bus, or the tape input. This allows easy monitoring of your choice of signals as you work, while the full mix continues to flow from the main outputs.

The Monitors control section is where you interact with these outputs. Turn the **Monitor** knob to set output level for the monitor outputs. Turn the **Phones** knob to set headphone volume. To get into more advanced monitoring settings, press the **Edit** button. This causes the Monitor screen to be displayed on the touchscreen.



On this screen, you can choose which signals to send to the monitor and headphone outputs. Touch the **Monitor** button to configure signal routing for the monitor outs. Press the **Phones** button to do so for the headphone output. In either case, a grid of available sources is shown (Solo, Main, Tape, Mix 1-16). Touching one or more of these sources routes them to the currently selected monitoring output.

***Power User Tip:** When the Solo system is in CR (control room) mode, soloing a channel or bus causes that signal to be sent to the monitor outputs, temporarily overriding any pre-existing routings to that output. When solo is disengaged, the routings you've chosen in the Monitor screen are restored. For more information on Solo Modes, see Section 9.1.*

The Delay control allows you to adjust the amount of delay applied to the headphone and control room output signals. Touch the **Delay** knob and turn the **Master Control** encoder to add delay to either output. This is useful for aligning the timing of the Front-of-House monitoring signal with the signal coming from the Front-of-House PA system. The PA sound must traverse the distance from the speakers to your mix position before you can hear it, so a certain amount of delay occurs, which can obscure the finer details of your mix when using the monitor outputs. Adjust this control until the phasing/flamming effects are minimized.

9.1 Solo Controls



The StudioLive features an independent Solo bus. This feature is extremely useful in setting levels for monitor mixes, dialing in dynamics processing on each channel, and fixing issues during a live show without interrupting the main mix.

The Solo bus has three different modes: AFL (default), PFL, and SIP.

- **AFL (After-Fader Listen).** AFL sends the channel or subgroup signal to the Solo bus post-fader so that you can control the level of the soloed signal with the fader. This is the StudioLive's default setting.
- **PFL (Pre-Fader Listen).** PFL sends the channel or subgroup signal to the Solo bus before it reaches the fader so the fader does not affect the soloed signal.

- **SIP (Solo In Place).** This is also known as “destructive solo.” When channels are soloed in this mode, every channel that isn’t soloed will be muted, and only the soloed channels will be sent to their assigned outputs. While useful in dialing in dynamics during soundcheck, this mode is dangerous during a live show. We recommend that this mode be turned off when mixing live events.

Power User Tip: To disengage solo for all soloed channels, press the **Clear** button in the Solo control section.

9.1.1 Solo Modes

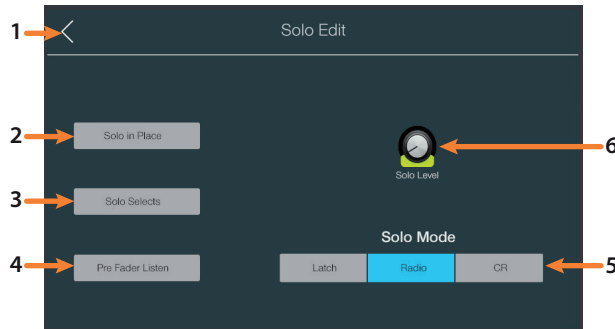

To access the Solo bus controls, press the **Edit** button in the Solo control section. This will make the following controls available in the Touchscreen.

1. **Exit.** Closes the Solo Edit screen.
2. **Solo In Place On/Off Button.** Enables Solo In Place. SIP (Solo In Place), or “destructive soloing,” mutes every unsoloed channel on the StudioLive. If one of the muted channels is routed to the mains or a subgroup, it will be muted in those outputs. This also applies to soloed channels: The output routing is still active. Note that while you can manually unmute a channel, this mode should be used with extreme caution during a live performance. Only the input channels can be placed in destructive soloing. The subgroups and aux buses are omitted from SIP mode.

Power User Tip: When SIP is engaged, channel mutes will only apply to the subgroup and main bus assignments. SIP does not mute input channels in aux-bus mixes. Because of this, you can use SIP to dial in a mix in the mains without disturbing the musicians’ last-minute rehearsal on stage.

Destructive soloing is also a great way to tune each channel’s dynamics individually in live-mixing situations or do surgical editing in the studio. SIP mode mutes every channel and bus that is not soloed in the Main bus (that is, if Channel 3 is soloed, you will only hear Channel 3 in your mains). This makes a great fine-tuning tool but it can quickly destroy a live mix. We highly recommend that you drop out of this mode once the show has started.

3. **Solo Selects.** When Radio Solo mode is enabled, the Solo Select option will be available. When Solo Select is active, soloing a channel will also select it. This is available for all three solo modes.
4. **PFL/AFL Toggle Button.** Enables Pre-Fader Listen (PFL) Soloing. The default setting for the Solo bus is After-Fader Listen (AFL); by pressing PFL, Pre-Fader Listening is enabled. In either mode, pressing Solo on any channel or bus routes that channel to the Solo bus and has no effect on the main or subgroup mixes.
 - PFL soloing is not available for the subgroups.
 - Aux bus soloing is always PFL, regardless of whether this mode is engaged.

5. **Solo Modes.** (Defaults to Radio mode) These buttons let you choose from the following behavioral modes for channel soloing:
 - **Latch.** In this mode, you can solo multiple channels or buses at once.
 - **Radio.** In this mode, only one channel or bus can be soloed at a time. When this mode is chosen, the Select Follows Solo button appears. Enabling this option causes channels and buses to be selected for Fat Channel editing when soloed (as though the corresponding Select button had been pressed).
 - **CR (Control Room).** In this mode, soloed signals are sent directly to the monitor output bus, temporarily disabling any other signals that are routed to that output. When solo is disengaged, any existing routings to the monitor outs are re-enabled.
6. **Cue Mix Level Control.** Adjusts the Overall Level of the Solo Bus. Touch this knob to adjust the overall level for the Solo bus with Master Control encoder.

9.1.2 Using the Solo Bus for Monitoring

When mixing live, or when recording multiple musicians at once, it is often necessary to quickly listen to just one instrument or group. The Solo and Monitor buses can be used together for this purpose. It is important to note that if you wish to monitor with speakers, rather than with headphones, it is necessary to connect the speakers to the Monitor Outs, rather than to the Main Outputs.

To use the Solo bus for monitoring purposes, do the following:

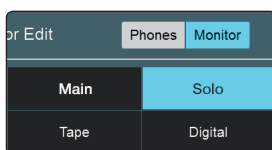
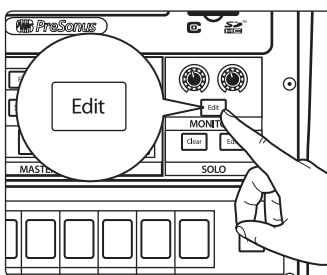
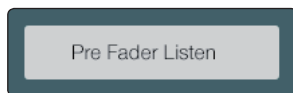
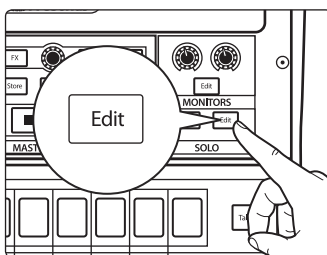

1. Press the **Edit** button in the Solo section to bring up the Solo screen.
2. Enable the **Pre-Fader Listen** option if you want to hear the soloed channels pre-fader (unaffected by fader level). Disable it if you want channel levels to be affected by fader levels.
3. Touch **Latch** in the Solo Mode section of the touchscreen to enable the Latch solo mode. This lets you solo multiple channels at the same time, which is usually desired, in this case.
4. Press the **Edit** button in the Monitors section to bring up the Monitor screen.
5. Press **Monitors** if you want to listen on your booth or control room speakers. Press Phones if you want to listen on headphones. This brings up a list of available sources to route to the chosen monitoring system.
6. Touch **Solo** on the touchscreen to route the Solo bus to the monitor system you've chosen.

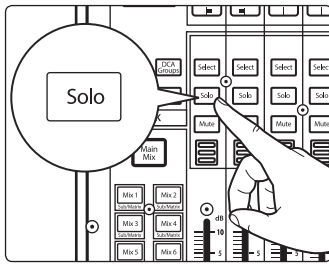

7. Press **Solo** on the channels or buses you want to monitor. The signal being fed to the Main outputs is unaffected.

9.1.3 Using Solo in Place to Set Up a Mix

We started this manual with a quick and easy way to set up the input levels for your StudioLive, ensuring that you have the highest possible input level without clipping your analog-to-digital converters. The next step is to set up your mix by dialing in the dynamics, EQ, and fader settings for each channel. This is a job for Solo In Place (SIP) mode. As previously mentioned, Solo In Place is a great way to dial in your mix without disturbing your musicians' last minute rehearsal or subjecting your audience to that impromptu jam session on stage. Radio Solo mode is especially useful for this purpose because it allows you to quickly solo just one channel at a time.

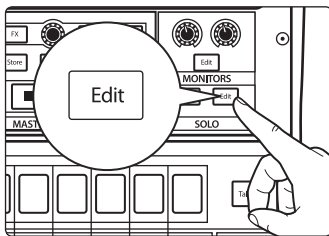

1. Press the **Edit** button in the Solo section to bring up the Solo screen.



2. Touch **Radio** in the Solo Mode section of the touchscreen to enable Radio Solo mode.
3. Touch **Solo in Place** on the touchscreen to enable Solo in Place mode.
4. Touch **Solo Selects** on the touchscreen to enable Solo Selects mode.
5. Raise your channel faders and Master fader to unity gain.

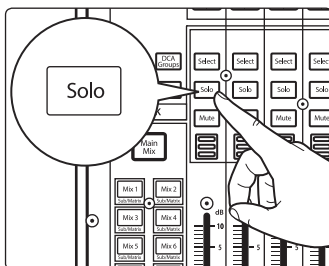
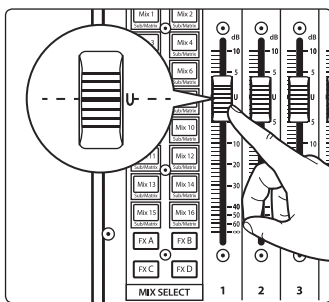

6. Many engineers start with the drums and work from the bottom up, so press the **Solo** button on your kick-drum mic channel. Notice that all the other channels on your StudioLive have been muted, and the kick-drum channel is selected.

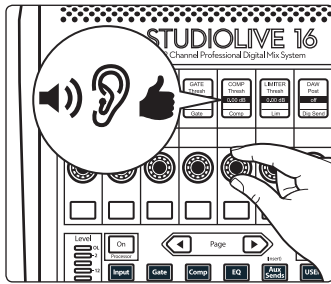

7. The Fat Channel is now focused on the selected channel, giving you access to EQ, dynamics, and effects settings for the kick-drum channel. Set these to your liking.
8. Once you're satisfied, press the **Solo** button on the next channel and repeat step 6. In this way, continue with each channel in your mix.
9. When you've finished, press the **Edit** button in the Solo section and touch **Solo in Place** on the touchscreen to disable it and set up your fader mixer.

***Power User Tip:** While Radio Solo mode is especially useful for setting levels as described above, it is not ideal for soloing during a live show. Because of this, once you have set your levels, go back to the Solo Edit menu and select either Latch or CR Solo Mode.*

10 Graphic EQ

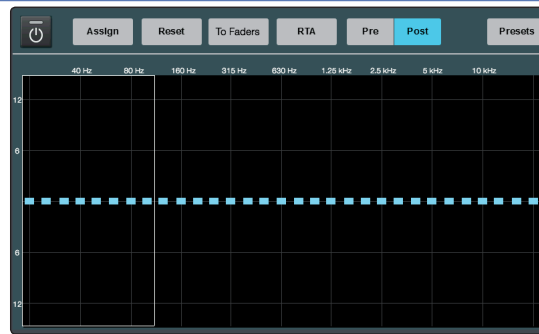

Your StudioLive comes packed with eight 31-band graphic EQ processors that can be freely assigned to the Main mix, or your choice of FlexMixes. These can be used for system tuning, subtle tweaks, or wherever you find them useful.

Graphic EQs are generally used to fine-tune the overall mix for a particular room. For instance, if you are mixing in a “dead” room, you may want to boost high frequencies and roll off some of the lows. If you are mixing in a “live” room, you might need to lower the high-midrange and highest frequencies. In general, you should not make drastic amplitude adjustments to any particular frequency band. Instead, make smaller, incremental adjustments over a wider spectrum to round out your final mix. To assist you with these adjustments, here is an overview of the way different frequency ranges affect sound characteristics:

Sub-Bass (16 Hz to 60 Hz). The lowest of these bass frequencies are felt, rather than heard, as with freeway rumbling or an earthquake. These frequencies give your mix a sense of power, even when they only occur occasionally. However, overemphasizing frequencies in this range will result in a muddy mix.

Bass (60 Hz to 250 Hz). Because this range contains the fundamental notes of the rhythm section, any EQ changes will affect the balance of your mix, making it fat or thin. Too much emphasis will make for a boomy mix.

Low Mids (250 Hz to 2 kHz). In general, you will want to emphasize the lower portion of this range and de-emphasize the upper portion. Boosting the range from 250 Hz to 500 Hz will accent ambience in the studio and will add clarity to bass and lower frequency instruments. The range between 500 Hz and 2 kHz can make midrange instruments (guitar, snare, saxophone, etc.) “honky,” and too much boost between 1 kHz and 2 kHz can make your mix sound thin or “tinny.”

High Mids (2 kHz to 4 kHz). The attack portion of percussive and rhythm instruments occurs in this range. High mids are also responsible for the projection of midrange instruments.

Presence (4 kHz to 6 kHz). This frequency range is partly responsible for the clarity of a mix and provides a measure of control over the perception of distance. If you boost this frequency range, the mix will be perceived as closer to the listener. Attenuating around 5 kHz will make the mix sound further away but also more transparent.

Brilliance (6 kHz to 16 kHz). While this range controls the brilliance and clarity of your mix, boosting it too much can cause some clipping so keep an eye on your main meter.

10.1 Assigning GEQs



To assign a Graphic EQ to one of the mixes, select the desired mix and press the **GEQ** button. This will open the GEQ screen:

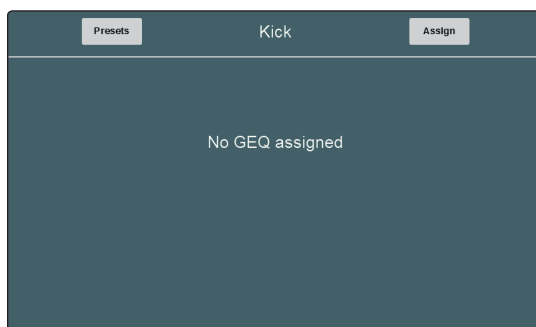

Press the **Assign** button to select the mix(es) on which you'd like to insert a GEQ. Touching a mix will insert a Graphic EQ post-fader:

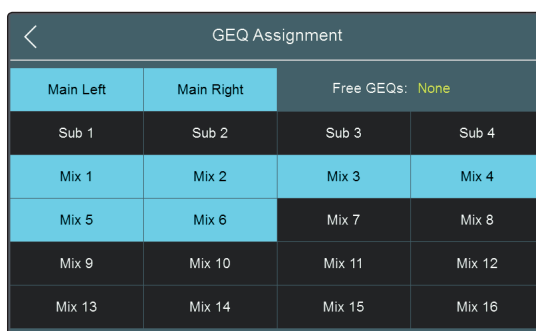

On the upper right hand side of the screen, you will see how many GEQs are available to be assigned.

Free GEQs: None

You will be alerted when all eight GEQs have been assigned.

Once assigned, you can access the GEQ at any time by pressing the **GEQ** button on your desired mix:

Use the Fat Channel encoders to control the Graphic EQ in banks of eight. Use the Master Control encoder to scroll to a different bank.

10.2 Using the GEQ

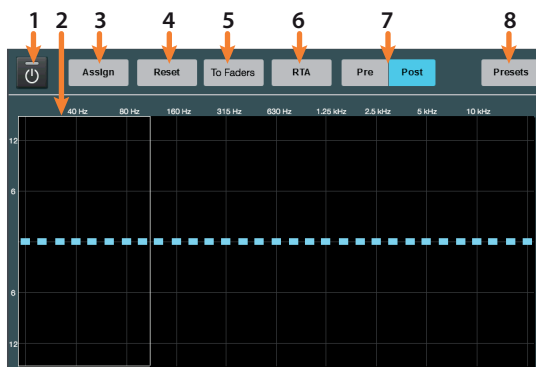

1. **On/Off.** Use this button to enable/disable the current GEQ.
2. **Current Bank.** By default, the GEQ is controlled from the Fat Channel encoders in banks of eight. This highlights the bank that is currently being controlled from the Fat Channel. Use the value encoder to move to another bank.
3. **Assign.** Opens the Assign GEQ screen. See Section 10.1.
4. **Reset.** Press this button to flatten the GEQ.

5. **To Faders.** Enable this button to control your GEQ from your StudioLive faders.
6. **RTA.** Enables the RTA. See Section 10.4.
7. **Pre/Post-GEQ.** Enables Pre- or Post-GEQ viewing on the RTA. See Section 10.4.
8. **Presets.** Opens the GEQ Presets screen. See Section 10.3.

10.3 GEQ Presets

To store or load a GEQ preset for the currently selected instance, touch the Presets button while the GEQ screen is active. This loads the GEQ Presets screen. In this screen, to load a preset, scroll through the list of existing presets, and touch the preset of your choice to select it. Press the Recall button to load the selected preset. To store a GEQ preset, press the Store button. A text entry field appears, letting you name your new preset. Touch Save to complete the process. Touch Cancel to cancel the process.

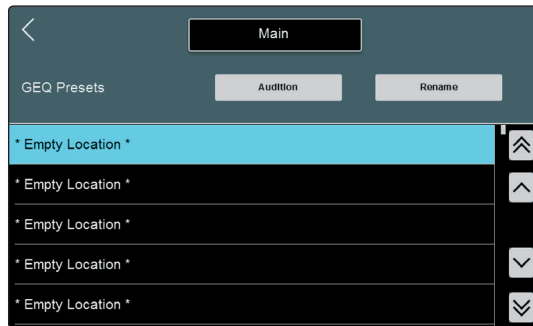

10.4 Using the RTA to Ring Out Monitors

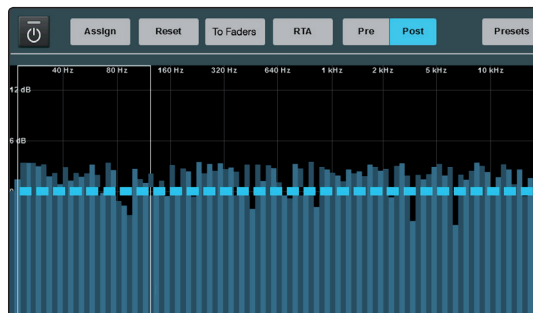

Every Graphic EQ is equipped with a Real-time analyzer, or RTA, in which $x = \text{frequency}$ and $y = \text{amplitude}$. As previously mentioned, an RTA provides a close visual representation of what you are hearing. It provides a view of the long-term spectrum of the signal—for example, the one-third-octave spectrum long-term average of a musical performance.

Feedback is short term for a feedback loop, where a portion of the signal from the speaker returns to the microphone, resulting in a constant tone at the offending frequency. “Ringing out” is a process of attenuating the frequencies that are feeding back to maximize gain before feedback in your floor monitors.

1. With the mic input gain at an appropriate level, bring the aux- send level up on the mic channel you wish to ring.

Power User Tip: If you are using one console for stage monitors and another console for front-of-house, set the mic input gain on the front-of-house console. Do not “gain up” the mic signal on the monitor mixer for the sake of getting more volume out of a stage monitor, as you can do that in other places (Mix level for individual channels, Aux Out level for global control, etc.). Gain staging is very important in order to have a feedback-free show.

2. Select the graphic EQ for the Aux Mix output of the stage monitor you are ringing out.
3. Open the Graphic EQ by pushing the GEQ button.

4. Slowly bring the aux output level up until you hear (and see) feedback.

Note: Ringing out stage monitors will produce feedback. If you are not careful, you can produce a lot of feedback. Do not make sudden gain boosts; go slowly and carefully to avoid causing any damage to speakers and ears.

5. Feedback will show up as a line peak on the RTA.
6. Lower the GEQ gain control for the offending frequency in 3 dB increments to attenuate it out of your stage monitor.

Power User Tip: Bring back the level on the GEQ slider to the point just before feedback so you don't take out too much frequency content and sacrifice overall timbre. Because the speaker is pointed at the mic, stage-monitor feedback typically occurs in the higher frequencies, which also is where intelligibility comes from. Maximizing your intelligibility and gain structure results in clearer-sounding monitors.

You can apply this process to the main system, as well. This is especially useful with applications requiring lavalier or podium mics. These types of microphones are typically omnidirectional condensers and are very prone to feedback.

In a main system, feedback is typically in the mid to low range. The frequencies that are regenerating and creating a feedback loop are those frequencies that are wrapping around the main system due to the loss of directional control of lower frequencies.

When you are ringing out a system, and more than two or three feedback loops are happening simultaneously, you have reached the level where stability can no longer be achieved. Try bringing down the overall output level or find a physical solution, such as moving the speaker or microphone.

11 Resources

11.1 Networking Overview

Networking your StudioLive Series III mixer involves both hardware and software components. The entire installation and configuration procedure is given in this manual, but before beginning, you must download and install UC Surface touch-control software onto a macOS or Windows computer or an iPad, as described in the StudioLive Software Library Reference Manual.

Computer Control and Audio Data Connections

Two types of data flow between your Series III mixer and your computer. We will describe them first, then show you different scenarios for connecting the Series III mixer to a computer.

Control: This is the primary connection between your StudioLive, your computer, your mobile device, and your iPad. From these external device, you can use UC Surface or QMix-UC (iOS and Android) to mix remotely and control most of your mixer settings or add a second screen to your system.

More information on Control Networking options can be found in **Section 8.3**.

Audio: Using the AVB connection on your StudioLive mixer allows you to record and playback audio from your Mac running macOS 10.11 or later. This connection is not necessary for mixing live sound. A single computer can be used both to control and to record from the StudioLive, or separate computers can be used for control and audio.

Most of the networking discussion in this manual concerns the control data connection, as this is most common application for networking your StudioLive.

Power User Tip: *Network connections occasionally require troubleshooting, especially when a lot of wireless networks are in use. Because of this, it is always a good idea to get your networked devices and StudioLive happily communicating before the pressure is on, and you have a singer trying to dial in a monitor mix while you're trying to mic the drum kit. So while the guitarist is flirting with the bartender, take a quick moment to get your iPad, iPhone, computer, and StudioLive happily communicating with each other.*

11.1.1 Wired Ethernet Control Setup

A wired Ethernet setup is the simplest:

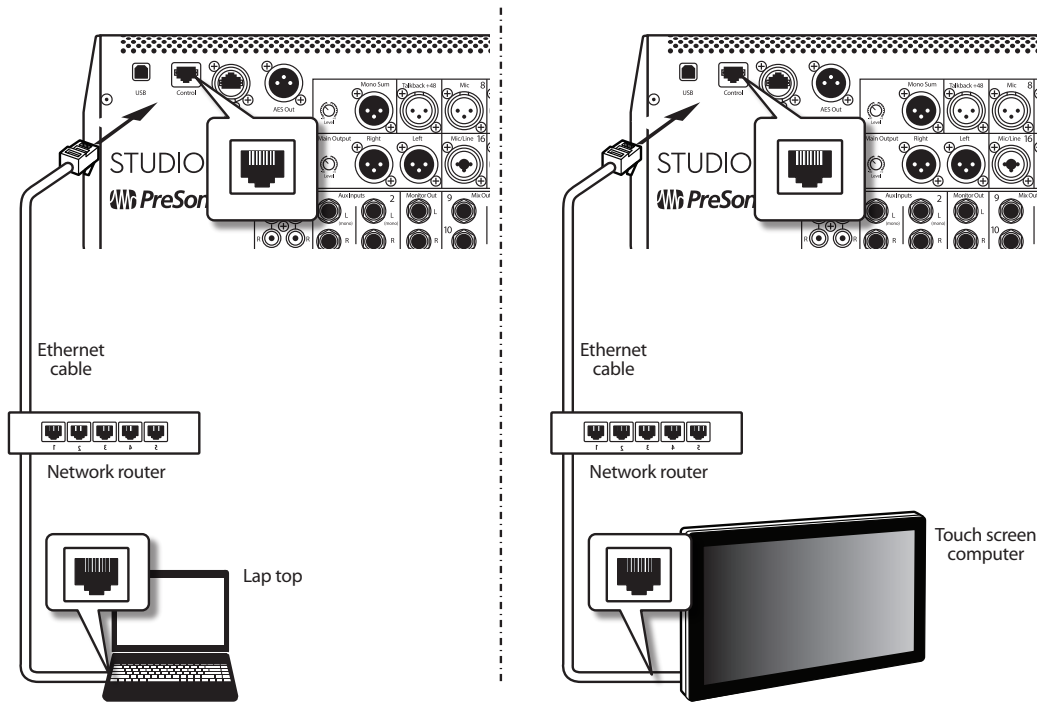

1. Connect standard CAT5e or CAT6 Ethernet cables from your computer's Ethernet port to an Ethernet router, and from the router to the Control port on the StudioLive's rear panel.
2. Launch Universal Control on the computer (macOS or Windows) that is connected to the router.
3. When Universal Control launch window appears. Tap on your mixer's icon to launch UC Surface.

For more information on UC Surface, *see the StudioLive Software Library Reference Manual.*

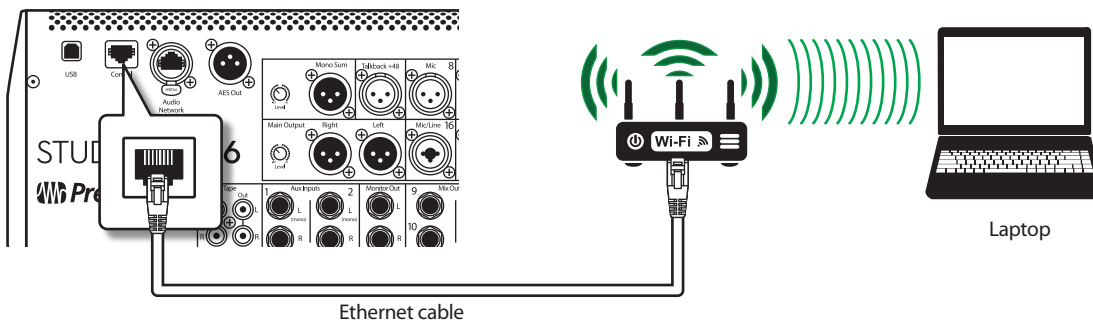

Using a wireless router, you can also connect your computer wirelessly:

Windows 7+

1. Click on the network icon in the notification area to open the Connect to Network Control Panel.
2. Select the name of the wireless network you set for your wireless router.
3. Enter the password.
4. Click Connect.

macOS 10.8 and later

1. On the Menu bar click on the Wireless Status icon.
2. Select the name of the wireless network you set for your wireless router.
3. Enter the password.
4. Click Join.

Note: Information on connecting your iOS device to the wireless network can be found in the StudioLive Software Library Reference Manual.

See Section 8.3 for information on customizing IP settings.

11.2 Stereo Microphone Placement

The following are a few recording applications to help you get started with your StudioLive. These are by no means the only ways to record these instruments. Microphone selection and placement is an art. For more information, visit your library or local bookstore, as there are many books and magazines about recording techniques. The Internet is also a great source of recording information, as are instructional videos. Some of these microphone-placement suggestions can be used in live applications, as well as for studio recording.

Grand Piano

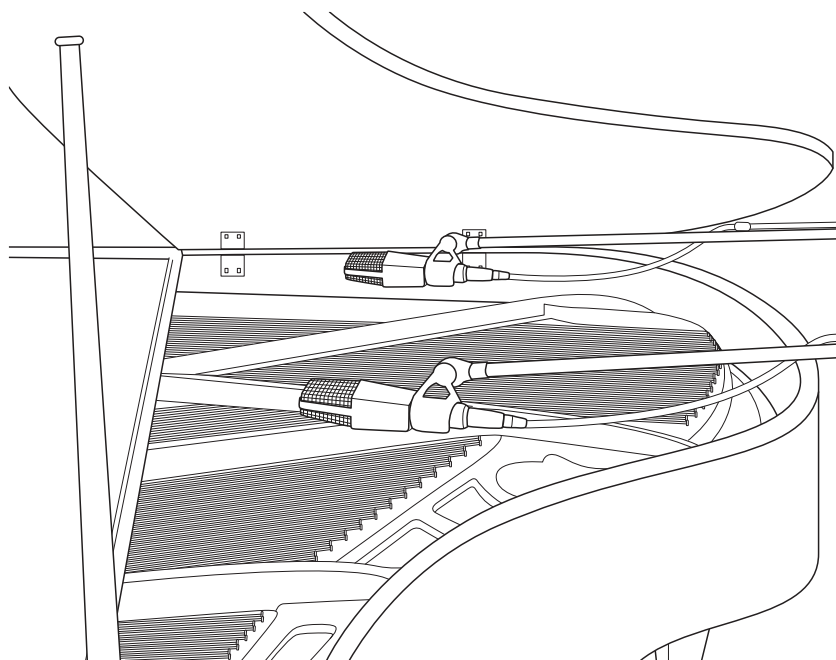

Place one microphone above the high strings and one microphone above the low strings. Experiment with distance (the farther back the more room you will capture). This technique can be used for live and studio applications.

Electric Guitar

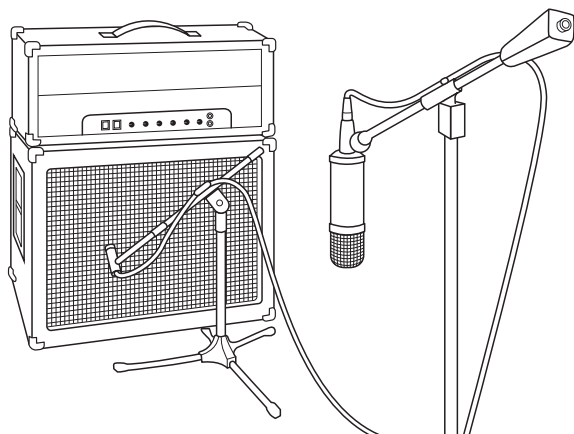

Place a dynamic microphone an inch or two away from the speaker of the guitar amplifier. Experiment with exact location. If you are recording an amp with multiple speakers, experiment with each one to see if one sounds better than the others. Place a condenser microphone approximately six feet away, pointed at the amp. Experiment with distance. Also experiment with inverting the phase of the room microphone to check for phase cancellation and reinforcement. (Select the "fuller"-sounding position.) To use this technique in a live application, omit the condenser microphone.

Acoustic Guitar

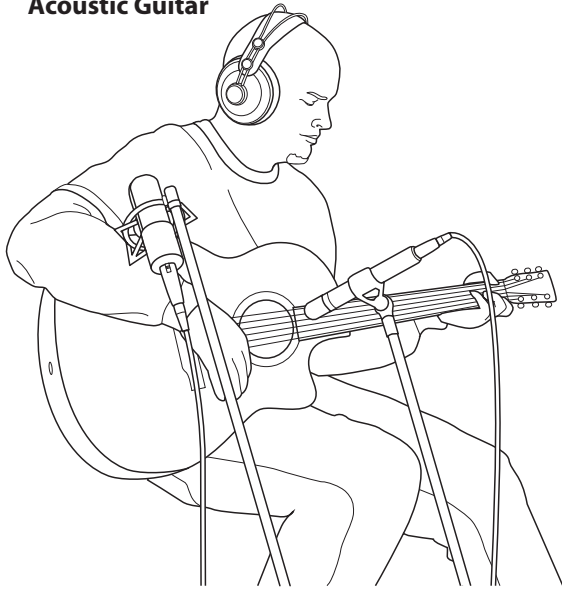

Point a small-diaphragm condenser microphone at the 12th fret, approximately 8 inches away. Point a large-diaphragm condenser microphone at the bridge of the guitar, approximately 12 inches from the guitar. Experiment with distances and microphone placement. Another popular method is using an XY microphone placement with two small-diaphragm condenser microphones. (See drum-overheads picture on the next page.)

Bass Guitar (Direct and Speaker)

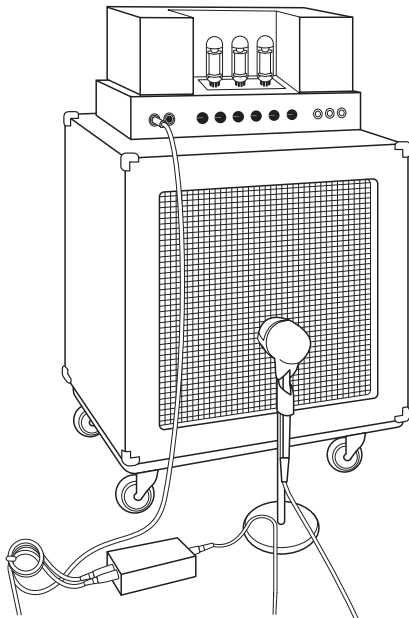

Plug the electric bass guitar into a passive direct box. Connect the instrument output from the passive direct box to a bass amplifier. Place a dynamic microphone an inch or two away from the speaker and connect it to a StudioLive microphone input. Connect the line output from the passive direct box to a line input on a different channel of the StudioLive. For recording, place these signals on separate tracks. During mixing, you can blend the direct and amplifier signal to taste. This technique can also be used in live applications.

Drum Overheads (XY example)

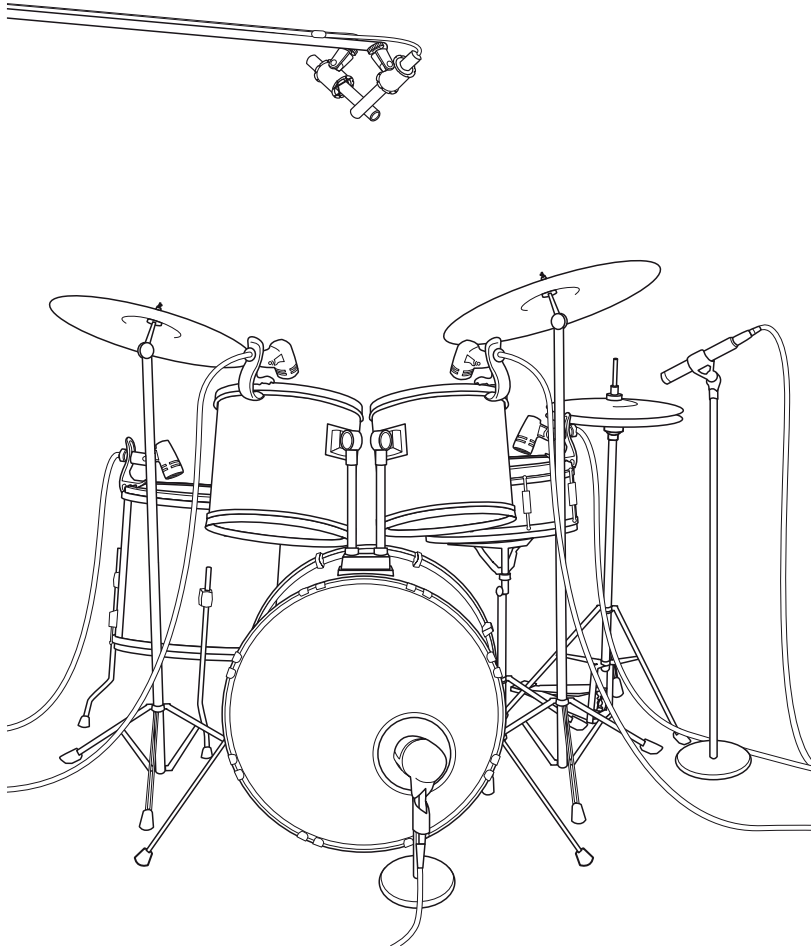

Place two small-diaphragm condenser microphones on an XY stereo-microphone holder (bar). Position the microphones so that each one is at a 45-degree angle, pointed down at the drum kit, approximately 7 or 8 feet above the floor or drum riser. Experiment with height. This technique can be used in live applications as well.

Snare Drum (top and bottom)

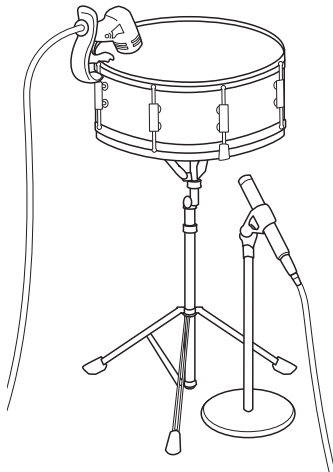

Point a dynamic microphone at the center of the snare, making sure it is placed so that the drummer will not hit it. Place a small-diaphragm condenser microphone under the drum, pointed at the snares. Experiment with the placement of both microphones. Also experiment with inverting the phase of the bottom microphone. This technique can be used in live applications.

11.3 Compression Setting Suggestions

The following are the compression presets that were used in the PreSonus BlueMax. We have included them as a jumping-off point for setting up compression on the StudioLive.

Vocals

Soft. This is an easy compression with a low ratio setting for ballads, allowing a wider dynamic range. It's good for live use. This setting helps the vocal "sit in the track."

THRESHOLD	RATIO	ATTACK	RELEASE
-8.2 dB	1.8:1	0.002 ms	38 ms

Medium. This setting has more limiting than the Soft compression setting, producing a narrower dynamic range. It moves the vocal more up front in the mix.

THRESHOLD	RATIO	ATTACK	RELEASE
-3.3 dB	2.8:1	0.002 ms	38 ms

Screamer. This setting is for loud vocals. It is a fairly hard compression setting for a vocalist who is on and off the microphone a lot. It puts the voice "in your face."

THRESHOLD	RATIO	ATTACK	RELEASE
-1.1 dB	3.8:1	0.002 ms	38 ms

Percussion

Snare/Kick. This setting allows the first transient through and compresses the rest of the signal, giving a hard "snap" up front and a longer release.

THRESHOLD	RATIO	ATTACK	RELEASE
-2.1 dB	3.5:1	78 ms	300 ms

Left/Right (Stereo) Overheads. The low ratio and threshold in this setting gives a "fat" contour to even out the sound from overhead drum mics. Low end is increased, and the overall sound is more present and less ambient. You get more "boom" and less "room."

THRESHOLD	RATIO	ATTACK	RELEASE
-13.7 dB	1.3:1	27 ms	128 ms

Fretted Instruments

Electric Bass. The fast attack and slow release in this setting will tighten up the electric bass and give you control for a more consistent level.

THRESHOLD	RATIO	ATTACK	RELEASE
-4.4 dB	2.6:1	45.7 ms	189 ms

Acoustic Guitar. This setting accentuates the attack of the acoustic guitar and helps maintain an even signal level, keeping the acoustic guitar from disappearing in the track.

THRESHOLD	RATIO	ATTACK	RELEASE
-6.3 dB	3.4:1	188 ms	400 ms

Electric Guitar. This is a setting for "crunch" electric rhythm guitar. A slow attack helps to get the electric rhythm guitar "up close and personal" and gives punch to your crunch.

THRESHOLD	RATIO	ATTACK	RELEASE
-0.1 dB	2.4:1	26 ms	193 ms

Keyboards

Piano. This is a special setting for an even level across the keyboard. It is designed to help even up the top and bottom of an acoustic piano. In other words, it helps the left hand to be heard along with the right hand.

THRESHOLD	RATIO	ATTACK	RELEASE
-10.8 dB	1.9:1	108 ms	112 ms

Synth. The fast attack and release on this setting can be used for synthesizer horn stabs or for bass lines played on a synthesizer.

THRESHOLD	RATIO	ATTACK	RELEASE
-11.9 dB	1.8:1	0.002 ms	85 ms

Orchestral. Use this setting for string pads and other types of synthesized orchestra parts. It will decrease the overall dynamic range for easier placement in the mix.

THRESHOLD	RATIO	ATTACK	RELEASE
3.3 dB	2.5:1	1.8 ms	50 ms

Stereo Mix

Stereo Limiter. Just as the name implies, this is a hard limiter, or “brickwall,” setting—ideal for controlling the level to a two-track mixdown deck or stereo output.

THRESHOLD	RATIO	ATTACK	RELEASE
5.5 dB	7.1:1	0.001 ms	98 ms

Contour. This setting fattens up the main mix.

THRESHOLD	RATIO	ATTACK	RELEASE
-13.4 dB	1.2:1	0.002 ms	182 ms

Effects

Squeeze. This is dynamic compression for solo work, especially electric guitar. It gives you that glassy “Tele/Strat” sound. It is a true classic.

THRESHOLD	RATIO	ATTACK	RELEASE
-4.6 dB	2.4:1	7.2 ms	93 ms

Pump. This is a setting for making the compressor “pump” in a desirable way. This effect is good for snare drums to increase the length of the transient by bringing the signal up after the initial spike.

THRESHOLD	RATIO	ATTACK	RELEASE
0 dB	1.9:1	1 ms	0.001 ms

11.4 EQ Frequency Guides

Table 1

Instrument	What to Cut	Why to Cut	What to Boost	Why to Boost
Human Voice	7 kHz	Sibilance	8 kHz	Big sound
	2 kHz	Shrill	3 kHz and above	Clarity
	1 kHz	Nasal	200-400 Hz	Body
	80 Hz and below	Popping P's		
Piano	1-2 kHz	Tinny	5 kHz	More presence
	300 Hz	Boomy	100 Hz	Bottom end
Electric Guitar	1-2 kHz	Shrill	3 kHz	Clarity
	80 Hz and below	Muddy	125 Hz	Bottom end
Acoustic Guitar	2-3 kHz	Tinny	5 kHz and above	Sparkle
	200 Hz	Boomy	125 Hz	Full
Electric Bass	1 kHz	Thin	600 Hz	Growl
	125 Hz	Boomy	80 Hz and below	Bottom end
String Bass	600 Hz	Hollow	2-5 kHz	Sharp attack
	200 Hz	Boomy	125 Hz and below	Bottom end
Snare Drum	1 kHz	Annoying	2 kHz	Crisp
			150-200 Hz	Full
			80 Hz	Deep
Kick Drum	400 Hz	Muddy	2-5 kHz	Sharp attack
	80 Hz and below	Boomy	60-125 Hz	Bottom end
Toms	300 Hz	Boomy	2-5 kHz	Sharp attack
			80-200 Hz	Bottom end
Cymbals	1 kHz	Annoying	7-8 kHz	Sizzle
			8-12 kHz	Brilliance
			15 kHz	Air
Horns	1 kHz	Honky	8-12 kHz	Big sound
	120 Hz and below	Muddy	2 kHz	Clarity
String section	3 kHz	Shrill	2 kHz	Clarity
	120 Hz and below	Muddy	400-600 Hz	Lush and full

Table 2

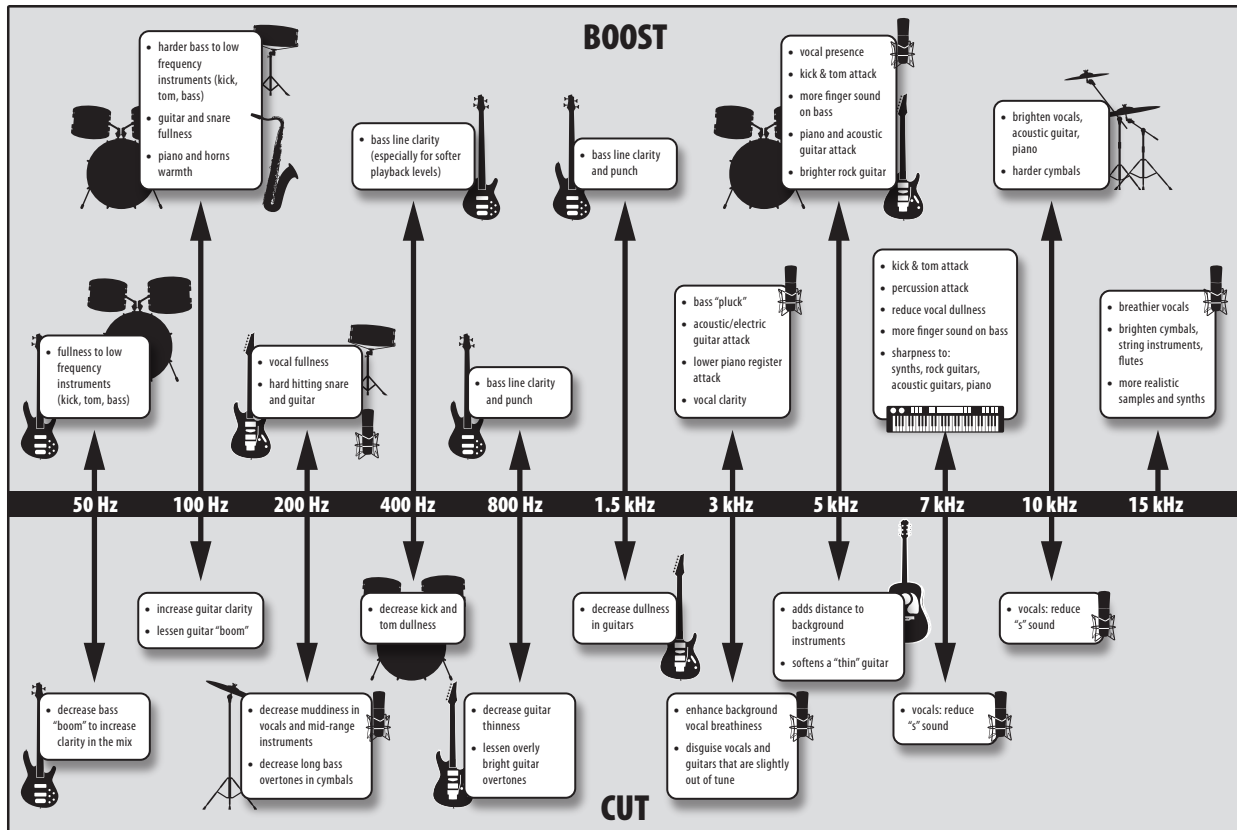

11.5 EQ Setting Suggestions

Included with your StudioLive is a library of Fat Channel presets. **Section 5.8** discusses how to load these presets onto a channel or bus and how to create your own presets. For an idea of where to start, check out the following generic EQ settings for several different instruments. As with the compression settings in **Section 11.3**, the right EQ setting for any given instrument will depend upon the room and the tonality of the instrument.

Vocals

Pop Female Vocals

LOW ON/OFF	LOW SHELF	LOW FREQ (Hz)	LOW Q	LOW GAIN	LOW MID ON/OFF	LOW MID FREQ (Hz)	LOW MID Q	LOW MID GAIN
ON	OFF	130	0.6	-2	ON	465	0.6	-2
HIGH MID ON/OFF	HI MID FREQ (kHz)	HIGH MID Q	HIGH MID GAIN	HIGH ON/OFF	HIGH SHELF	HIGH FREQ (kHz)	HIGH Q	HIGH GAIN
ON	2.4	0.4	+2	ON	OFF	6.0	0.3	+8

Rock Female Vocals

LOW ON/OFF	LOW SHELF	LOW FREQ (Hz)	LOW Q	LOW GAIN	LOW MID ON/OFF	LOW MID FREQ (Hz)	LOW MID Q	LOW MID GAIN
ON	ON	155	N/A	+4	ON	465	0.4	+6
HIGH MID ON/OFF	HI MID FREQ (kHz)	HIGH MID Q	HIGH MID GAIN	HIGH ON/OFF	HIGH SHELF	HIGH FREQ (kHz)	HIGH Q	HIGH GAIN
ON	1.4	0.6	+6	ON	OFF	4.2	0.5	+2

Pop Male Vocals

LOW ON/OFF	LOW SHELF	LOW FREQ (Hz)	LOW Q	LOW GAIN	LOW MID ON/OFF	LOW MID FREQ (Hz)	LOW MID Q	LOW MID GAIN
ON	OFF	225	0.3	-2	ON	960	0.3	0
HIGH MID ON/OFF	HI MID FREQ (kHz)	HIGH MID Q	HIGH MID GAIN	HIGH ON/OFF	HIGH SHELF	HIGH FREQ (kHz)	HIGH Q	HIGH GAIN
ON	2.0	0.6	+2	ON	OFF	7.2	0.5	+4

Rock Male Vocals

LOW ON/OFF	LOW SHELF	LOW FREQ (Hz)	LOW Q	LOW GAIN	LOW MID ON/OFF	LOW MID FREQ (Hz)	LOW MID Q	LOW MID GAIN
ON	OFF	155	0.5	+2	ON	265	0.3	-6
HIGH MID ON/OFF	HI MID FREQ (kHz)	HIGH MID Q	HIGH MID GAIN	HIGH ON/OFF	HIGH SHELF	HIGH FREQ (kHz)	HIGH Q	HIGH GAIN
ON	2.4	0.6	-2	ON	ON	7.2	0.6	+4

Percussion

Snare

LOW ON/OFF	LOW SHELF	LOW FREQ (Hz)	LOW Q	LOW GAIN	LOW MID ON/OFF	LOW MID FREQ (Hz)	LOW MID Q	LOW MID GAIN
ON	OFF	130	0.6	-4	ON	665	0.5	+4
HIGH MID ON/OFF	HI MID FREQ (kHz)	HIGH MID Q	HIGH MID GAIN	HIGH ON/OFF	HIGH SHELF	HIGH FREQ (kHz)	HIGH Q	HIGH GAIN
ON	1.6	0.3	+4	ON	ON	4.2	N/A	+4

Left/Right (Stereo) Overheads

LOW ON/OFF	LOW SHELF	LOW FREQ (Hz)	LOW Q	LOW GAIN	LOW MID ON/OFF	LOW MID FREQ (Hz)	LOW MID Q	LOW MID GAIN
ON	OFF	108	0.6	-2	ON	385	0.6	-2
HIGH MID ON/OFF	HI MID FREQ (kHz)	HIGH MID Q	HIGH MID GAIN	HIGH ON/OFF	HIGH SHELF	HIGH FREQ (kHz)	HIGH Q	HIGH GAIN
ON	2.9	0.3	0	ON	ON	8.0	N/A	+4

Kick Drum

LOW ON/OFF	LOW SHELF	LOW FREQ (Hz)	LOW Q	LOW GAIN	LOW MID ON/OFF	LOW MID FREQ (Hz)	LOW MID Q	LOW MID GAIN
ON	OFF	108	0.4	+4	ON	265	2.0	-4
HIGH MID ON/OFF	HI MID FREQ (kHz)	HIGH MID Q	HIGH MID GAIN	HIGH ON/OFF	HIGH SHELF	HIGH FREQ (kHz)	HIGH Q	HIGH GAIN
ON	1.6	0.6	0	ON	OFF	6.0	2.0	+4

Fretted Instruments

Electric Bass

LOW ON/OFF	LOW SHELF	LOW FREQ (Hz)	LOW Q	LOW GAIN	LOW MID ON/OFF	LOW MID FREQ (Hz)	LOW MID Q	LOW MID GAIN
ON	ON	36	N/A	-8	ON	130	0.4	+4
HIGH MID ON/OFF	HI MID FREQ (kHz)	HIGH MID Q	HIGH MID GAIN	HIGH ON/OFF	HIGH SHELF	HIGH FREQ (kHz)	HIGH Q	HIGH GAIN
ON	2.0	0.6	+4	ON	ON	4.2	N/A	+1

Acoustic Guitar

LOW ON/OFF	LOW SHELF	LOW FREQ (Hz)	LOW Q	LOW GAIN	LOW MID ON/OFF	LOW MID FREQ (Hz)	LOW MID Q	LOW MID GAIN
ON	OFF	155	0.4	+4	ON	665	2.0	+2
HIGH MID ON/OFF	HI MID FREQ (kHz)	HIGH MID Q	HIGH MID GAIN	HIGH ON/OFF	HIGH SHELF	HIGH FREQ (kHz)	HIGH Q	HIGH GAIN
ON	2.0	0.3	0	ON	ON	6.0	N/A	+4

Distorted Electric Guitar

LOW ON/OFF	LOW SHELF	LOW FREQ (Hz)	LOW Q	LOW GAIN	LOW MID ON/OFF	LOW MID FREQ (Hz)	LOW MID Q	LOW MID GAIN
ON	OFF	320	0.5	+6	ON	960	0.4	0
HIGH MID ON/OFF	HI MID FREQ (kHz)	HIGH MID Q	HIGH MID GAIN	HIGH ON/OFF	HIGH SHELF	HIGH FREQ (kHz)	HIGH Q	HIGH GAIN
ON	3.5	1.0	+4	ON	ON	12	N/A	0

Keyboards

Piano

LOW ON/OFF	LOW SHELF	LOW FREQ (Hz)	LOW Q	LOW GAIN	LOW MID ON/OFF	LOW MID FREQ (Hz)	LOW MID Q	LOW MID GAIN
ON	ON	108	N/A	-2	ON	665	0.2	+2
HIGH MID ON/OFF	HI MID FREQ (kHz)	HIGH MID Q	HIGH MID GAIN	HIGH ON/OFF	HIGH SHELF	HIGH FREQ (kHz)	HIGH Q	HIGH GAIN
ON	2.9	0.4	+2	ON	OFF	7.2	0.6	+4

11.6 Using Input Delay

When one of the input channels is selected, you can set an input delay up to 85 ms in 0.1 ms increments. An input delay has many uses.

On small stages where the guitar amp and the kick and snare mics can be clearly heard in the vocal mic, an input delay can “move up” the backline. Delaying the backline so that the close mic’d signals and the bleed in the vocal mic align with one another at the mixer will decrease comb filtering that blurs in the mix. This will tighten the overall mix and give it more clarity and punch.

In large venues, the bottom snare mic can be aligned with the top mic, or the bass-cabinet mic can be aligned with the direct signal to create a more coherent signal. This is especially useful to prevent phasing problems.

11.6.1 Aligning the Backline with Vocal Mic

In this example, we will delay the guitar amp's close mic to its arrival at the vocal mic. In general, snare drums and guitar amps are the most common culprits of backline bleed. Depending on where your vocalist is standing, either one or both could need to be delayed to compensate for whatever amount of comb filtering is present.

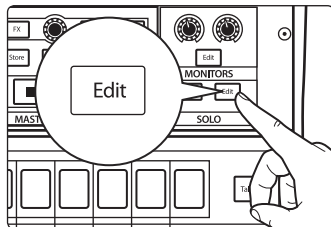
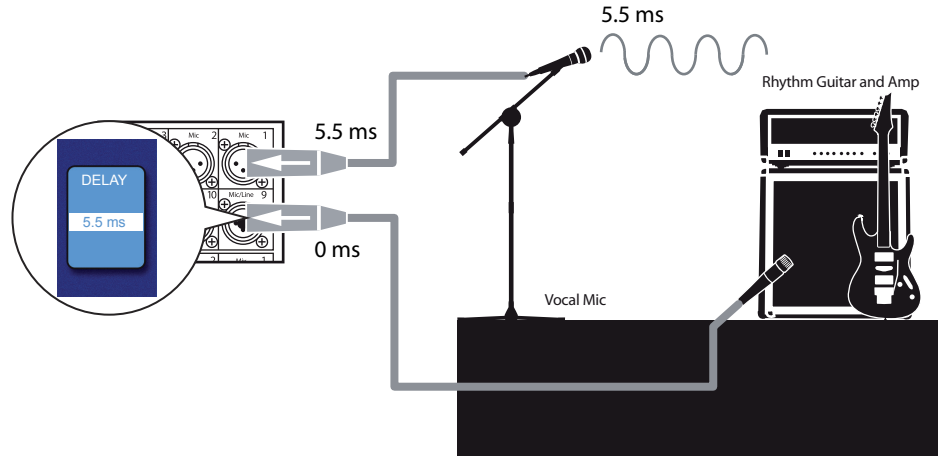

1. To begin, press the **Solo edit** button.



2. On the Touchscreen, select **Solo In Place** and **Latching Solo** mode.

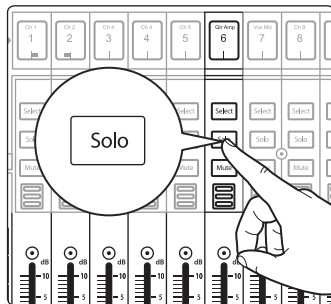

3. Solo the guitar and vocal channels; notice that all other channels are muted.
4. Measure the distance from the guitar cabinet to the vocal mic. Sound travels at a rate of 1,130 feet per second. This means you need to set 1.1 ms of delay for every foot of distance. For our example, let's say the guitar amp is 5 feet from the vocal mic.

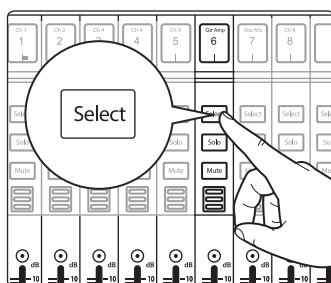

5. Press the guitar channel's **Select** button.

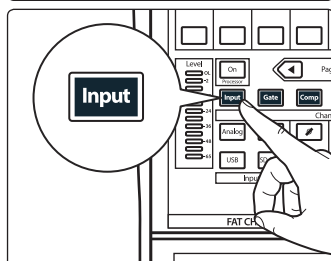

6. Press the **Input** button in the Fat Channel.

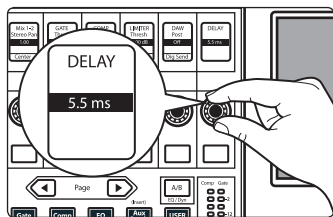

7. Use the eighth encoder to the input delay to 5.5 ms.
8. Ask your guitarist to play a staccato pulse and listen for any remaining flammings. Move up or down 0.1 ms until you hear the tightest sound.

11.6.2 Aligning Direct and Mic'd Signals

When combining a direct input signal with a mic'd signal from a single source, the direct sound will arrive earlier than the microphone's signal because the latter's source has to travel some distance through the air before reaching the microphone. This results in the two signals being out of phase with respect to each other. This problem can sometimes be corrected by alternatively flipping polarity on the direct and microphone channels to find which combination of the two signals provides the desired result. However, by using input delay it is possible to achieve a closer, more accurate phase relationship.

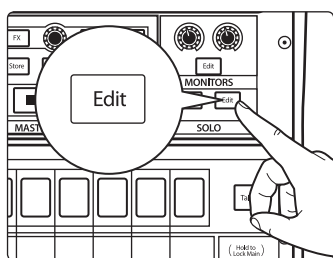

Solo in Place

1. To begin, press the **Solo edit** button.
2. On the Touchscreen, select **Solo In Place** and Latching Solo Mode.
3. Solo both the Direct Input channel and the microphone channel.
4. Set the pan position of both channels to the center. This will sum both signals mono and allow you to better hear the phase differences between the channels.
5. Press the Direct Input Channel's **Select** button.
6. Press the **Input** Button in the Fat Channel.
7. Increase the delay time on the Direct Input channel. This is the easiest way to hear the change in phase between the two signals. Listen to both till you find a happy medium between the combined signals.

Power User Tip: *The final result may not be perfectly in time but this is not necessarily your goal. Adjusting the phase relationship between the direct and mic'd signals can help to create space in a mix and keep the sounds coherent.*

11.7 Using Output Delay

When one of the output buses is selected, you can set an output delay up to 170 ms in 0.1 ms increments. When speakers are placed apart from one another, listeners will hear the sound from the closest source before they will hear it from the furthest. This is because electricity travels much faster to each loudspeaker than the acoustic waves travel from each loudspeaker to the listener. This can also be an issue when the acoustic level of an instrument or amplifier on stage can be heard over the same instrument or amplifier being reproduced by a loudspeaker. This can dampen the attack and intelligibility of the sound and create an unpleasant phasing effect. To compensate, you need to delay the signal going to the speakers closest to the listener.

In small venues where the guitar amp and the drum kit can be clearly heard over the Main Front-of-House system, an output delay can "move back" the Front-of-House system to the backline. This will sharpen the attack of the instruments and prevent phasing issues.

In large venues that push the limits of the Front-of-House system's coverage, using delay speakers distributed throughout the room, each delayed to the main system, allows you to create listening zones for more even coverage and better intelligibility.

Sound travels at a rate of 1,130 feet per second (with some variation due to temperature, humidity, and elevation). Therefore, it takes 1.1 ms for sound to travel one foot. For example, it takes about 11 ms for sound to travel 10 feet. So if you are aligning your Front-of-House system is 10 feet from your drum kit, you need to delay the signal going to that system by 11 ms.

There are professional software products that can calculate the exact alignment times, but with a little math and little careful listening, this can be dialed in without extra accessories.

11.7.1 Front-of-House

In a small venue with a relatively small stage, both the main speaker system and the acoustic level of guitar amps and the drum kit on stage can be heard by listeners in the audience. This can reduce the intelligibility of the speaker system because, for example, the mic'd snare signal and the acoustic snare signal are arriving at the listener's ear at different times. This is where output delays come in.

The first thing you will need to do is to find the loudest instrument on the stage. In general, this is the snare drum, but it could be the guitar amp, so let your ears do the deciding.

1. Measure the distance from the snare drum to the mid-frequency drivers of your main Front-of-House system and multiply it by 1.1 (if measured in feet) or 0.34 (if measured in meters).
2. On your StudioLive mixer, select the Main mix and set the Output delay to the result of your calculation.
3. Bring up the level of the snare channel on your mixer to unity and have your drummer play single hits on the snare, about one hit every second. Make sure he or she plays at the level they will play during the performance.
4. Use your Main mix level to set the level on the Front-of-house system as closely to the acoustic level of the snare drum as possible.
5. Listen closely to the speakers and the snare and make minor adjustments to the output delay until the attack times sound as coherent as possible.

11.7.2 Delay Systems

In most situations, a PA system relies on a main speaker system, positioned at the front of the room, to reproduce audio for the entire performance space. As a result, the level of the system is considerably louder at the front of the room than it is at the mix position.

In situations where sound must be reproduced outside of the main system's optimum range, well-placed delay systems can extend the intelligibility of the front-of-house system. By creating listening zones throughout the room, your front-of-house system only needs to be loud enough to cover the front of the room. As a result, you can lower the mains level, give the front-row listeners' ears a break, and get better fidelity from your speakers.

When placing delay systems, place delay systems where the main system's intelligibility falls apart as it is overcome by environmental obstacles:

Inside. Indoors, you are trying to overcome the direct-to-reverberant reflections. Your goal is to find where the direct signal-to-reverberation ratio has reached about 50/50. At this point, the reflections in the room are at an equal level to the direct sound of the P.A., and vocal intelligibility is lost.

Outside. Outdoors, you are trying to maintain level as the noise floor of the crowd begins to be at equal level to the P.A. in the intelligibility range. At this point, the main system needs more support in order to deliver the same perceived loudness as you get further from the source.

The goal of distributed sound is for the people in the back row have the same listening experience as the people in the front, but it isn't as easy as just bringing an extra pair of speakers. To create a distributed sound system, you need to delay the signal going to the additional speakers.

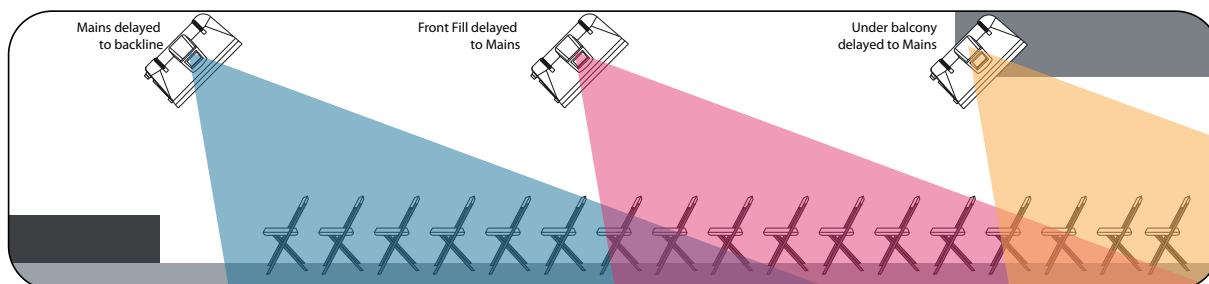

1. Once you have positioned your delay systems, measure the distance from the left front-of-house speaker to the closest delay speaker (most likely, the left side delay speaker). Multiply the distance by 1.1 (if measured in feet) or 0.34 (if measured in meters).
2. On your StudioLive mixer, select the FlexMix driving the output connected to your left side delay speaker and configure it as a Subgroup.
3. Set the Output delay on your newly created subgroup to the result of your calculation.
4. Repeat steps 1-3 with the right side of the system.
5. Once you have positioned and delayed your satellite system, use an SPL meter to match the output of the main and delay systems at the measurement point. For example, if you are standing 30 feet from the left side of the main system and 10 feet from the left side of the delay system, and the output of the main system is 85 dB, then the output of the delay system should also be 85 dB.

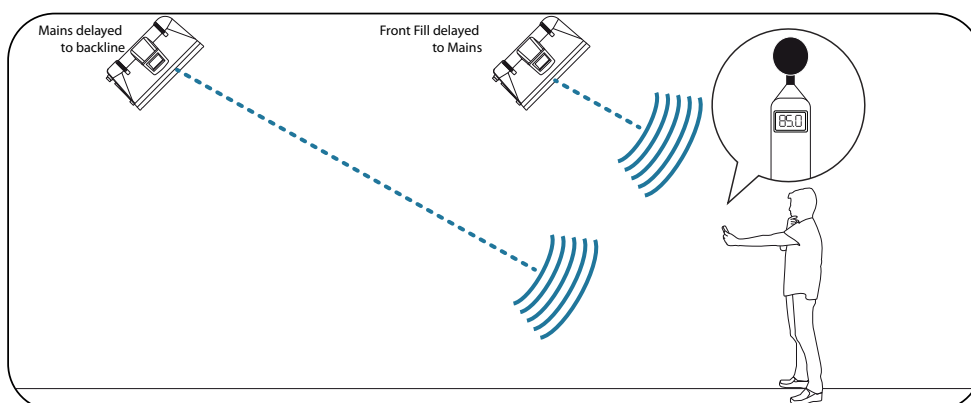

It should be noted that frequencies in the sub-bass range of a delay system do not require distribution. In fact, a delay system's high pass filter should be rolled up as high as 300 to 400 Hz to avoid sound going back toward the stage as low frequencies become omnidirectional.

11.7.3 Aligning Subs to Mains

When your subwoofer and your full-range loudspeaker are placed some distance apart, low-frequency cancellation or reinforcement can occur when the same frequencies are reproduced by both systems. Using an alignment delay on your subwoofer system will compensate for this. To set the correct delay for a custom installation, you will need to do some calculating:

1. Find the spot in the room where coverage from the main speakers and the subwoofers overlap.

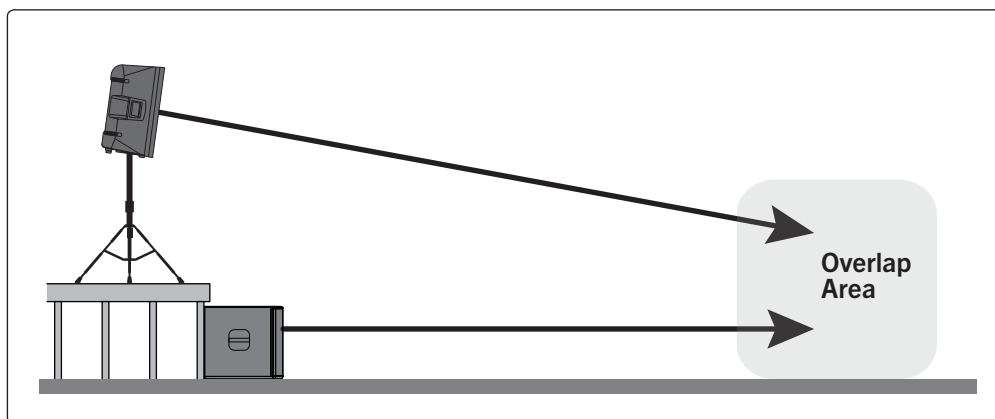

2. Measure the distance from the overlap area to each speaker location.
3. Subtract the smaller distance (the distance to the subwoofer) from the larger distance (the distance to the full-range loudspeaker).
4. Multiply the distance by 1.1 (if measured in feet) or 0.34 (if measured in meters) and apply that delay value to the Aux mix driving the subwoofer. Keep in mind that the overlap area may be behind front-of-house.

11.8 Effect Types

Your StudioLive mixer is equipped with four stereo effects processors. Each of these processors has its own aux bus, allowing you to independently control the mix of channels feeding them. This section will guide you through the basics of several common effect types.

11.8.1 Reverb and its Parameters

Reverberation—or reverb, as it is more commonly known—is perhaps the most widely used effect. Natural reverb is created by sound waves reflecting off of a surface or many surfaces. For example, when you walk across the wooden stage in a large hall, thousands of reflections are generated almost instantaneously as the sound waves bounce off the floor, walls, and ceilings. These are known as early reflections, and their pattern provides psycho-acoustic indications as to the nature of the space that you are in, even if you can't see it. As each reflection is then reflected off of more surfaces, the complexity of the sound increases, while the reverb slowly decays.

The reason for the widespread use of reverb in audio recording is fairly self-evident: human beings don't live in a vacuum. Because our brains receive cues about the nature of the space around us based partially on audio reflections, a sense of space makes an audio recording sound more natural and, therefore, more pleasing.

Below are some of the most common reverb parameters for the reverb effects:

Decay. Decay is the time (in seconds) required for the reflections (reverberation) to die away. In most modern music production, reverb decay times of between one and three seconds are prevalent. A reverb setting with strong early reflections and a quick decay are a great way to create a stereo effect from a mono source.

Predelay. Predelay is the time (in milliseconds) between the end of the initial sound and the moment when the first reflections become audible. Imagine you're back on that stage in a large music hall. This time you stand on the very edge of the stage and shout "Hello world!" toward the center of the hall. There will be a brief pause before you hear the first noticeable reflections of your voice, because the sound waves can travel much further before encountering a surface and bouncing back. (There are closer surfaces, of course—notably the floor and the ceiling just in front of the stage—but only a small part of the direct sound will go there, so those reflections will be much less noticeable.) Adjusting the predelay parameter on a reverb allows you to change the apparent size of the room without having to change the overall decay time. This will give your mix a little more transparency by leaving some space between the original sound and its reverb.

Early Reflections. Early reflections are those that reach the listener a few milliseconds after the direct signal arrives. Your brain uses them to identify the size of the room you're in. If you are trying to simulate a specific type of room, this control will be extremely important. This control allows you to set the level (in decibels) of the early reflections. The louder the early reflections, the smaller the room will seem.

11.8.2 Delay and its Parameters

A delay essentially creates an echo, although you can often use delays to create more complex time-based effects. The source signal is delayed so that it is heard later than it actually occurred.

Below are some of the most common reverb parameters for the delay effects:

Time. This is the time (in milliseconds) between the source signal and its echo. The simplest delay effect is a single repeat. A short delay between 30 and 100 ms can be used to create slap-back echo, while longer delay times produce a more distant echo. Delay times that are too short to hear as distinct echoes can be used to create thickening effects. Whether these echoes are timed with the tempo is a matter of stylistic choice.

This is the parameter that is controlled by the Tap Tempo button. Using the Tap button on the StudioLive, you can speed up or slow down these repeats or, more commonly, time the repeats to occur with the tempo of the music.

Power User Tip: While you have to select the Time parameter in order to use the Tap button, you only have to do this the first time you use the Tap button for that effect. Once the Tap button has been used to control the Time parameter, it will always control the time of that particular delay, no matter what page you are currently viewing. To assign the Tap button to control another delay, simply navigate to that delay's Time parameter and use the button to enter the desired delay time.

Time X. Time X is the value of the beat you are using as a reference for the tempo. The basic unit of measure is a quarter note, so for example, if the beats you are tapping represent quarter notes in the music, you would set Time X to 1.00. If they are eighth notes, you would set Time X to 0.50; half notes would be 2.00; and so on. In this way, you can precisely synchronize or syncopate the delay echoes to the music in real time.

Variable Feedback. Variable feedback, or regeneration, produces multiple decaying repeats. Increasing the feedback value increases the number of echoes, as well as the resonance that is created as one echo disappears into another.

F_Frequency. Sets the center frequency in Hz for the Filter Delay. **F_Gain.** Sets the boost at the center frequency for the Filter Delay.

F_Q. Sets the Q for the Filter Delay. The Q is the ratio of the center frequency to the bandwidth. When the center frequency is constant, the bandwidth is inversely proportional to the Q, so as you raise the Q, you narrow the bandwidth.

11.8.3 Chorus and Flange

Close relatives of delay effects, modulation effects change the pitch and time of a delayed signal using a Low Frequency Oscillator or LFO. Two of the most common modulation effects are chorus and flange.

Created by mixing two identical signals together and delaying one of the signals by a constantly varying time, the flanger is perhaps the simplest of modulation effects. The resulting effect creates a kind of whooshing sound as the delay signal rises and falls in varying parts of the frequency spectrum.

Similar to a flanger, a chorus effect is created by mixing the source signal with one or more pitch-shifted copies of it. Each copy is then modulated by an LFO. A chorus is different from a flanger in several ways. First, the time between the modulated delay signal and the original source signal is longer in a chorus than it is in a flanger. Also, a flanger only has one delayed signal, whereas a chorus may have two or more. And finally, choruses do not feed any of the processed signal back into the processor.

Below are some of the most common parameters for the flanger and chorus effects:

Rate. Sets the frequency of the LFO modulating the delayed signal.

Width. Shifts the phase of the LFO modulating the delayed signal.

Shape. Sets the type of wave form the LFO will use to modulate the delayed signal.

Delay Offset. This is the time (in milliseconds) between the source signal and the delayed signal.

Delay Modulation Amplitude. Sets the speed of the LFO modulating the delayed signal.

Delay Feedback. Variable feedback, or regeneration, produces multiple decaying repeats. Increasing the feedback value increases the number of echoes, as well as the resonance that is created as one echo disappears into another.

11.9 Technical Specifications

Microphone Preamplifier

Input Type	XLR Female, balanced
Frequency Response to Main Output (at unity gain)	20-20 kHz, ± 0.5 dBu
Input Impedance	1 k Ω
THD to Main Output	<0.005%, +4 dBu, 20-20 kHz, unity gain, unwt'd
S/N Ratio to Main Output (Ref = +4 dB, 20 kHz BW, unity gain, A-wtd)	94 dB
Common Mode Rejection Ratio (1 kHz at unity gain)	65 dB
Gain Control Range (± 1 dB)	0 dB to +60 dB
Maximum Input Level (unity gain)	+12 dBu
Phantom Power (± 2 VDC)	48 VDC, switchable per channel

Line Inputs

Type	¼" TRS Female, balanced
Frequency Response to Main Output (at unity gain)	20-20 kHz, ± 0.5 dBu
Input Impedance	10 k Ω
THD to Main Output	<0.005%, +4 dBu, 20-20 kHz, unity gain, unwt'd
S/N Ratio to Main Output (Ref = +4 dB, 20 kHz BW, unity gain, A-wtd)	94 dB
Maximum Input Level	+18 dBu

Tape Inputs

Type	RCA Female, unbalanced (stereo pair)
Maximum Input Level	+12 dBu, ± 0.5 dBu

XLR Outputs

Type	XLR Male, balanced
Maximum Output Level	+24 dBu, ± 0.5 dBu
Output Impedance	100 Ω

Line Outputs

Type	¼" TRS Female, balanced
Maximum Output Level	+18 dBu, ± 0.5 dBu
Output Impedance	100 Ω

Tape Outputs

Type	RCA Female, unbalanced (stereo pair)
Maximum Output Level	+18 dBu, ± 0.5 dBu
Output Impedance	100 Ω

Headphone Output

Type	¼" TRS Female, active stereo
Maximum Output	100 mW/ch. @ 60 Ω load
Frequency Response	20 Hz – 20 kHz (± 0.5 dB)
THD+N	0.01%, 1 kHz, max gain, 20 Hz BW, unwt'd
S/N Ratio	96 dB, 1 kHz, max gain, 20 Hz BW, unwt'd

System Crosstalk

Input to Output	-90 dB (Ref = +4 dBu, 20 Hz-20 kHz, unwt'd)
Adjacent Channels	-87 dB (Ref = +4 dBu, 20 Hz-20 kHz, unwt'd)

Digital Audio and Control

ADC Dynamic Range	115 dB (A-wtd, 48 kHz)
DAC Dynamic Range	115 dB (A-wtd, 48 kHz)
USB Recording Port	USB 2.0, Type-B
Bluetooth™ Input	4.1, stereo
AES/EBU Output	XLR Male
Network Control Port	RJ-45
AVB Audio Network Port	Ethercon
Internal Processing	32-bit, floating point
Sampling Rate	48 kHz
A/D/A Bit Depth	24
Reference Level for 0 dBFS	+18 dBu
Total System Latency	1.9 ms (local routing, analog in-analog out, all processing active)

Clock

Jitter	<20 ps RMS (20 Hz - 20 kHz)
Jitter Attenuation	>60 dB (1 ns in, 1 ps out)

Power / Environmental

Connector	IEC
Input-Voltage Range	90 to 230 VAC (±10%)
Power Requirements (continuous)	85W
Recommended Ambient Operating Temperature	0° to 40° Celsius / 32° to 104° Fahrenheit

Physical

Height	7" (179 mm)
Width	StudioLive 16: 18" (457 mm); StudioLive 24: 25.6" (650 mm); StudioLive 32: 32.5" (826 mm)
Depth	23" (584 mm)
Weight	StudioLive 16: 23 lbs. (10.5 kg); StudioLive 24: 30 lbs. (13.6 kg); StudioLive 32: 37.2 lbs. (16.9 kg)

11.10 Block Diagrams

The block diagrams for our StudioLive Series III mixers are too large to be included in this manual. Please visit the following pages on our website for the latest Series III block diagrams in Adobe PDF format:

[StudioLive 16 block diagram](#) [StudioLive 24 block diagram](#)

[StudioLive 32 block diagram](#)

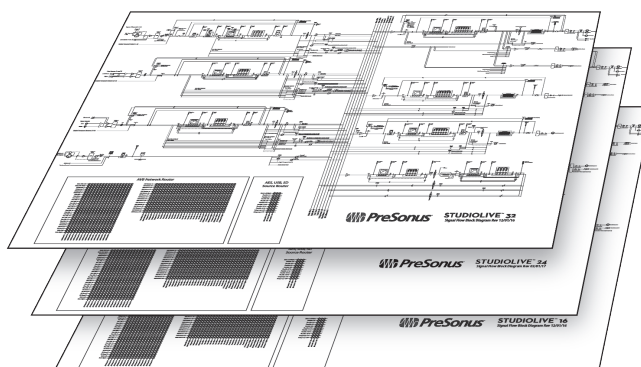

12 Troubleshooting and Warranty

12.1 Troubleshooting

Please check the PreSonus Web site (www.presonus.com) regularly for software information and updates, firmware updates, and support documentation, including frequently asked questions.

Online technical support is available to registered users through your My PreSonus account. Visit my.presonus.com to register.

Fader Movements Have No Effect on Audio. Press the **Main** button in the Mix Select section, then try moving channel faders up and down, to see if their movement affects the overall output volume, as shown by the main output meter. If not, make sure that your channels are assigned to the Main bus.

No Internal Effects in the Main Bus. Press the Aux button in the Metering section and verify the output levels of the internal FX A-D aux buses. If the level is too low, use the effect return channel to increase the master level for the effects mix. Press the Select button for each FX bus and make sure it is assigned to the main output in the Assign section of the Fat Channel.

No Output on the Solo Bus While Monitoring. Verify that both the Solo volume and the headphone, or monitor, volume is at a reasonable level for comfortable listening. Make sure that you only have Solo selected in the Monitor section of your StudioLive.

Buttons/Knobs Are Not Functioning. If your StudioLive is passing audio but you have no Fat Channel, fader, or menu control, verify that the StudioLive is not locked by navigating to the Global Lockout screen in the home menu.

Can't Hear Main Mix in Headphones. Verify that the Main mix is enabled as the source for the headphones and that the headphone output control is at a sufficient level.

Monitor Bus Controls Not Changing Routing. Verify that your monitors are connected to the Control Room outputs on the rear panel of your StudioLive, not the Main outputs.

Main Fader Doesn't Control Mix Level. Verify that your monitors are connected to the Main outputs on the rear panel of your StudioLive, not the Control Room outputs.

13 Warranty Information

PreSonus' warranty obligations for this hardware product are limited to the terms set forth below:

13.1 How Consumer Law Relates To This Warranty

THIS WARRANTY GIVES YOU SPECIFIC LEGAL RIGHTS, AND YOU MAY HAVE OTHER RIGHTS THAT VARY FROM STATE TO STATE (OR BY COUNTRY OR PROVINCE). OTHER THAN AS PERMITTED BY LAW, PRESONUS DOES NOT EXCLUDE, LIMIT OR SUSPEND OTHER RIGHTS YOU MAY HAVE, INCLUDING THOSE THAT MAY ARISE FROM THE NONCONFORMITY OF A SALES CONTRACT. FOR A FULL UNDERSTANDING OF YOUR RIGHTS YOU SHOULD CONSULT THE LAWS OF YOUR COUNTRY PROVINCE OR STATE.

13.2 PreSonus Products And EU Statutory Warranty

When you purchase PreSonus products, European Union consumer law provides statutory warranty rights in addition to the coverage you receive from the PreSonus limited warranty. A summary of the EU Statutory Warranty and the PreSonus Limited Warranty is below:

	EU Consumer Law	PreSonus Limited Warranty
Repair or Replacement Coverage For	Defects present when customer takes delivery	Defects arising after customer takes delivery
Warranty Period	2 years (minimum) from original date of purchase (unless superseded by PreSonus)	1 year from original date of purchase (unless superseded by PreSonus)
Cost of Coverage	Provided at no additional cost	Included at no additional cost
Who to contact to make a claim	The seller	PreSonus technical support for your region

13.3 What This Warranty Covers

PreSonus Audio Electronics, Inc., ("PreSonus") warrants defects in material and workmanship in PreSonus-branded products under normal use. This Limited Warranty applies only to hardware products manufactured by or for PreSonus that can be identified by the PreSonus trademark, trade name, or logo affixed to them.

13.4 Exclusions and Limitations

This warranty does **not** cover the following:

1. Damage caused by accident, abuse, improper installation, failure to follow instructions in the applicable owner's manual or improper operation, rental, product modification, alteration, or neglect.
2. Damage from improper grounding, faulty wiring (AC and signal), faulty equipment, or connection to a voltage range outside published specifications (see applicable owner's manual).
3. Damage to drivers or diaphragm assemblies found to have burnt voice coils from over/under driving or signal surge from another device.
4. Damage occurring during shipment or improper handling.
5. Damage caused by repair or service performed by persons not authorized by PreSonus.
6. Products on which the serial number has been altered, defaced, or removed.
7. Products purchased from an unauthorized PreSonus dealer (products that have transferable warranties are excluded from this provision provided the customer and the product are registered with PreSonus).

13.5 Who This Warranty Protects

This Warranty protects only the original retail purchaser of the product (products that have transferable warranties are excluded from this provision provided the customer and the product are registered with PreSonus)

13.6 How Long This Warranty Lasts

A 1-Year Limited Warranty begins on the original date of purchase from the retail purchaser.

13.7 What PreSonus Will Do

PreSonus will repair or replace, at our sole and absolute option, products covered by this warranty at no charge for labor or materials. If the product must be shipped to PreSonus for warranty service, the customer must pay the initial shipping charges. PreSonus will pay the return shipping charges.

13.8 How to Get Warranty Service (USA)

1. You must have an active user account with PreSonus and your hardware must be on file with your account. If you do not have an account, please go to <https://my.presonus.com> and complete the registration process.
2. Contact our Technical Support Department at (225) 216-7887 or log a support ticket at: <http://support.presonus.com>. TO AVOID THE POSSIBILITY OF SENDING IN A PRODUCT THAT DOES NOT HAVE A PROBLEM, ALL SERVICE REQUESTS SHALL BE CONFIRMED BY OUR TECH SUPPORT DEPARTMENT.
3. The return authorization number, as well as shipping instructions, shall be provided after your service request is reviewed and confirmed.
4. The product should be returned for service in the original product packaging. Products may be shipped in a manufactured "flight" or "road" style cases but PreSonus will NOT cover any shipping damage to these cases. Products that are not shipped in the original product package or a manufactured case may not receive a warranty repair, at PreSonus' sole discretion. Depending on the product model and the condition of your original packaging, your product may not be returned to you in the original packaging. The return shipping box may be a generic box that has been fitted for that model tested if the original gift box is not available.

13.9 How to Get Warranty Service (outside of USA)

1. You must have an active user account with PreSonus and your hardware must be on file with your account. If you do not have an account, please go to: <https://my.presonus.com> and complete the registration process.
2. Contact the Technical Support/Service Department for your region at www.presonus.com/buy/international_distributors and follow procedures provided by your PreSonus contact.

13.10 Limitation of Implied Warranties

ANY IMPLIED WARRANTIES, INCLUDING WARRANTIES OF MERCHANTABILITY AND FITNESS FOR A PARTICULAR PURPOSE, ARE LIMITED IN DURATION TO THE LENGTH OF THIS WARRANTY.

Some states, countries, or provinces do not allow limitations on how long an implied warranty lasts, so the above limitation may not apply to you.

13.11 Exclusion of Damages

PRESONUS'S LIABILITY FOR ANY DEFECTIVE PRODUCT IS LIMITED TO THE REPAIR OR REPLACEMENT OF THE PRODUCT, AT PRESONUS'S SOLE OPTION. IF PRESONUS ELECTS TO REPLACE THE PRODUCT, THE REPLACEMENT MAY BE A RECONDITIONED UNIT. IN NO EVENT WILL PRESONUS BE LIABLE FOR DAMAGES BASED ON INCONVENIENCE, LOSS OF USE, LOST PROFITS, LOST SAVINGS, DAMAGE TO ANY OTHER EQUIPMENT OR OTHER ITEMS AT THE SITE OF USE, AND, TO THE EXTENT PERMITTED BY LAW, DAMAGES FOR PERSONAL INJURY, OR ANY OTHER DAMAGES WHETHER INCIDENTAL, CONSEQUENTIAL OR OTHERWISE, EVEN IF PRESONUS HAS BEEN ADVISED OF THE POSSIBILITY OF SUCH DAMAGES.

Some states, countries, or provinces do not allow limitations on how long an implied warranty lasts, so the above limitation may not apply to you.

If you have any questions about this warranty or service received, please contact PreSonus (USA) at +1-225-216-7887 or contact one of our authorized international distributors at www.presonus.com/buy/international_distributors.

Product features, design, and specifications are subject to change without notice.

Added bonus: PreSonus' previously Top Secret recipe for...

Garfish Balls

Ingredients:

- 5 lbs ground garfish
- 4 white potatoes
- 1 large onion
- 2 celery stalks
- 1 bunch parsley
- 6 green onions
- 1 tsp cayenne pepper
- 1 tsp black pepper
- 2 tsp salt
- Flour

Cooking Instructions:

1. Peel potatoes and boil until tender. Set aside to cool.
2. Finely dice onion and celery and sauté in butter until tender. Set aside to cool.
3. Grind garfish in a meat grinder or food processor.
4. Mash potatoes with cooked vegetables.
5. Finely chop green onions and parsley.
6. Combine ground garfish with potato mixture, parsley, green onions, pepper, and salt. Mix well.
7. Form baseball-sized balls and set on a chilled cookie sheet.
8. Roll each ball in flour.
9. Heat 1/2-inch of cooking oil in skillet.
10. Set balls in cooking oil and flatten into patties with a spatula.
11. Cook for approximately 1-2 minutes and flip. Cook for another minute until cooked through.
12. Remove from oil and set aside to drain.
13. Serve with brown gravy over rice.

Serves 12

This recipe will make approximately 24 garfish balls. Balls can be frozen at step 8. Do not freeze cooked patties.

Garfish have a lot of bones that can be difficult to remove. It's recommended to request that it be deboned by your fish monger if possible. It can also be substituted for cod or whiting...but garfish is better.

StudioLive™ Series III

Digital Mix Console / Recorder with Motorized Faders

Owner's Manual



18011 Grand Bay Ct. • Baton Rouge,
Louisiana 70809 USA • 1-225-216-7887
www.presonus.com

Part# 70-2200045-B