



fos/4 Panel

User Manual

Version 1.0.0

Part Number: 7471M1200-1.0.0 Rev: A

Released: 2020-01

To view a list of ETC trademarks and patents, go to etcconnect.com/ip. All other trademarks, both marked and not marked, are the property of their respective owners.

ETC intends this document, whether printed or electronic, to be provided in its entirety.

Table of Contents



Introduction	1
Help from ETC Technical Services	2
Safety	3
Overview	5
Fixture	5
User Interface	6
Set Up and Focus the Fixture	7
Mount the Fixture	7
Add Accessories	8
Connect Power and Data	8
Focus the Fixture	9
Use Fixture in DMX Mode	10
Set DMX Address	10
Set DMX Mode	10
Set DMX Loss Behavior	12
Use Fixture in Stand-alone Mode	13
Studio Mode	14
Color Mode	15
Effects Mode	16
Preset Mode	17

Set Up Wireless Control	18
Set Up Multiverse Wireless Communication	18
Control Fixtures Wirelessly Using the Set Light App	18
Control and Customize the Display	19
Lock the Display	19
Adjust the Display Backlight and Display Timeout	19
Troubleshooting and Maintenance	20
Troubleshooting Checklist	20
Test the Emitters	22
View Diagnostic Data	22
View Battery Level	23
Export Fixture Data for Troubleshooting	23
Restore Default Settings	24
Update Firmware	24
Backup and Restore the Fixture Configuration	25
Clean the Diffusion	25
Specifications and Reference	26
Environment	26
Dimensions and Weight	26
Electrical	27
RDM Parameters	27
Fixture Compliance	28
Wireless Radio Compliance	28

Introduction

The fos/4 Panel provides an incredibly bright, top quality, highly tunable light. The Panel is available in three sizes, and each size is available in two array types:

- **Lustr X8:** The next generation of the Lustr color system incorporates deep red into the already amazing x7 mix to create an even more rich, vibrant X8 color palette.
- **Daylight HDR:** Years of research resulted in an LED mix that yields the highest quality tunable white light, optimized for studio use.

Model	Array Type	Array Size	Weight
fos4PL8	Lustr X8	 20.3 x 61 cm (8 x 24 in)	14.5 kg (32 lb)
fos4PD8	Daylight HDR		
fos4PL16	Lustr X8	 40.6 x 61 cm (16 x 24 in)	25.4 kg (56 lb)
fos4PD16	Daylight HDR		
fos4PL24	Lustr X8	 61 x 61 cm (24 x 24 in)	35.8 kg (79 lb)
fos4PD24	Daylight HDR		

Help from ETC Technical Services

If you are having difficulties and your problem is not addressed by this document, try the ETC support website at support.etcconnect.com or the main ETC website at etcconnect.com. If none of these resources are sufficient, contact ETC Technical Services directly at one of the offices identified below. Emergency service is available from all ETC offices outside of normal business hours.

When calling for help, take these steps first:

- Prepare a detailed description of the problem
- Go near the equipment for troubleshooting
- Find your notification number if you have called in previously

Americas

ETC, Inc.
Technical Services Department
3031 Pleasant View Road
Middleton, WI 53562
800-775-4382 (USA, toll-free)
+1-608 831-4116
service@etcconnect.com

Asia

ETC Asia
Technical Services Department
Room 1801, 18/F
Tower 1, Phase 1 Enterprise Square
9 Sheung Yuet Road
Kowloon Bay, Kowloon, Hong Kong
+852 2799 1220
techservasia@etcconnect.com

France

ETC France
62-64 rue Danielle
Casanova
Saint-Denis Cedex,
F93200
+33 1 4243 3535
techservltd@etcconnect.com

United Kingdom

ETC Ltd
Technical Services Department
26-28 Victoria Industrial Estate
Victoria Road,
London W3 6UU England
+44 (0)20 8896 1000
techservltd@etcconnect.com

Germany

ETC GmbH
Technical Services Department
Ohmstrasse 3
83607 Holzkirchen, Germany
+49 (80 24) 47 00-0
techserv-hoki@etcconnect.com

Safety

IMPORTANT SAFEGUARDS

When using electrical equipment, basic safety precautions should always be followed including the following:

READ AND FOLLOW ALL SAFETY INSTRUCTIONS

- Do not use outdoors.
- Do not let power supply cords touch hot surfaces.
- Do not mount near gas or electric heaters.
- Equipment should be mounted in locations and at heights where it will not readily be subjected to tampering by unauthorized personnel.
- The use of accessory equipment not recommended by the manufacturer may cause an unsafe condition.
- Do not use this equipment for other than intended use.

SAVE THESE INSTRUCTIONS



WARNING: Note the following safety warnings before use:

- Use the fixture in dry locations only, where humidity does not exceed 90 percent (non-condensing).
- Connect the fixture to a non-dimmable power source in order to avoid damage to the fixture's internal power supply and other electrical components. Using a dimmable power source can damage the fixture and will void the warranty.



WARNING: Note the following safety warnings before use:

- Disconnect the fixture from power and DMX and allow it to cool before installing accessories or performing any cleaning and maintenance.
- Only use mounting hardware that is rated for the total weight of the fixture and accessories.
- In addition to primary suspension, attach a safety cable (or other approved safety device) to the fixture. Safety cables must be rated to support six times the fixture weight. See [Mount the Fixture on page 7](#).
- Check that the accessory holder is locked and that any accessory safety cables are connected before mounting the fixture.
- Do not mount the fixture on or near a flammable surface.
- Do not operate the fixture without the diffusion installed.
- Do not use this fixture with a damaged power lead. If the power lead (cord set) is damaged, it must be replaced.
- Do not use this fixture if the diffusion is deeply scratched or cracked. You must replace the diffusion when it is damaged.



AVERTISSEMENT : Prendre connaissance des avertissements de sécurité suivants avant toute utilisation :

- Débranchez le projecteur de son alimentation et du DMX et laissez-le refroidir avant d'installer des accessoires ou d'effectuer un nettoyage ou un entretien.
 - N'utilisez que de la quincaillerie de montage adaptée au poids total des projecteurs et des accessoires.
 - En plus de la suspension principale, fixez une chaîne de sécurité (ou tout autre dispositif de sécurité homologué) au projecteur. Les chaînes de sécurité doivent être en mesure de supporter six fois le poids du projecteur.
 - Vérifiez que le porte-accessoires est verrouillé et que les élingues de tous les accessoires sont bien attachées avant de monter le projecteur.
 - Ne pas installer le projecteur sur ou à côté d'une surface inflammable.
 - N'utilisez pas le projecteur sans que le diffuseur soit installé.
 - Ne pas utiliser ce projecteur avec un cordon d'alimentation endommagé. Si le cordon d'alimentation (câble) est abîmé, il doit être remplacé.
 - N'utilisez pas ce projecteur si le diffuseur présente des rayures ou des fissures profondes. Il faut remplacer le diffuseur s'il est abîmé.
-

Overview

Fixture

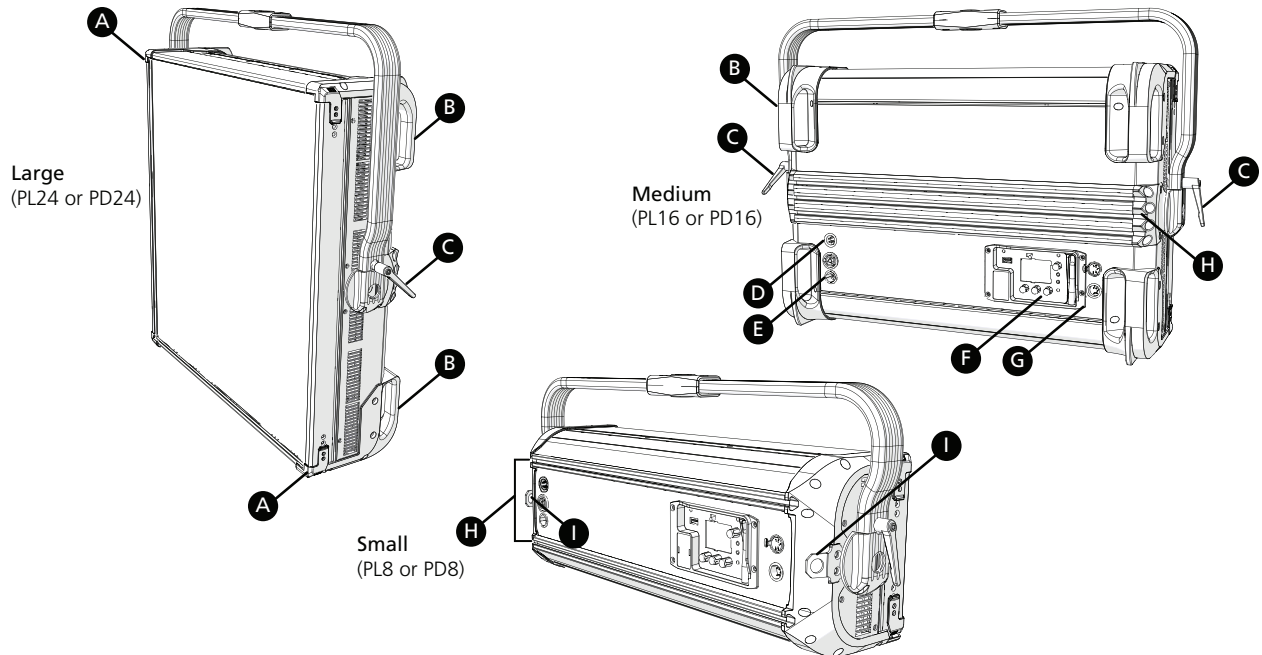

A	Accessory holder: Insert accessories into the two available slots from either side of the holder, and then lock the holder (page 8).
B	Handles: For medium (PL16 or PD16) and large (PL24 or PD24) fixtures, carry the fixture by the pairs of handles on the back of the fixture, and attach safety cables to handles when mounting the fixture (page 7).
C	Yoke tilt-lock: Tilt the fixture as needed, and then turn the tilt-lock clockwise to lock the position. If necessary, press the center button on the tilt-lock to adjust the tilt-lock position.
D	Battery connector: Four-pin XLR connector for battery power (not available on PL24 or PD24). Connect the fixture to battery power only when AC power is not available. Do not connect the fixture to a battery and to AC power at the same time.
E	Power In and Power Thru connectors: powerCON® TRUE1 TOP connectors for power in and power thru. The large fixture (PL24 or PD24) has a connector for power in only (no power thru connector).
F	User interface: View the fixture status, set the DMX address and mode, or set stand-alone options.
G	DMX In and DMX Thru connectors: Five-pin XLR connectors for DMX/RDM in and DMX/RDM thru.
H	Griprail: Attach standard accessories and mounting hardware to the back of the fixture using the hardware provided with the accessories or using M6 standard T-nuts.
I	Safety cable attachment points: Small (PL8 or PD8) fixture only. For large and medium fixtures, attach safety cables to handles (B), either the top pair or the bottom pair (page 7).

User Interface

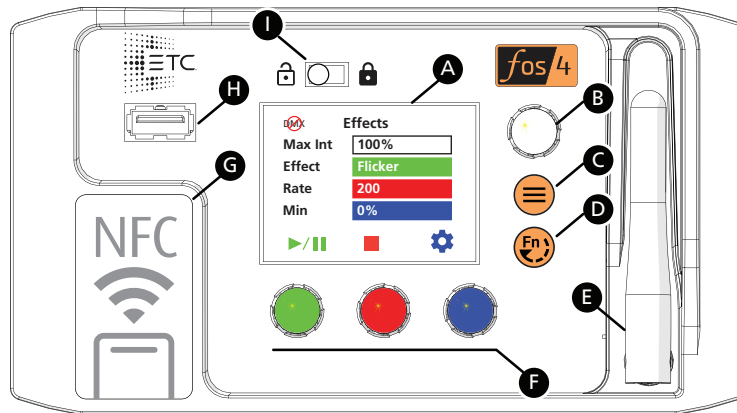

A	Display: The colors of options on the display correspond to the colors of the encoders below the display (F) and the Intensity encoder to the right of the display (B).
B	Intensity encoder: <ul style="list-style-type: none"> • When in DMX mode, press the Intensity encoder to enter Focus mode when focusing the fixture. • When configuring the fixture in one of the stand-alone modes, press the Intensity encoder to toggle between the current intensity and 0, or turn the Intensity encoder to modify the white fields on the display. See Use Fixture in Stand-alone Mode on page 13. • When navigating from the Main Menu screen, turn the Intensity encoder to scroll through menu options, and then press the Intensity encoder to select a menu option.
C	Menu button: Press to view the Main Menu screen and configure the fixture. Press the button again to return to the previous screen when you are setting configuration options.
D	Function button: Press repeatedly to toggle through the following modes: <ul style="list-style-type: none"> • Studio: Use one of three studio (white light) presets, or customize the presets. • Color: Use one of 12 color presets, or customize the presets. • Preset: Use one of 12 presets (color preset + fade time), or customize the presets. • Effects: Use one of 12 effects, or customize the effects. • DMX: View and set DMX parameters for the fixture. See Use Fixture in Stand-alone Mode on page 13 and Use Fixture in DMX Mode on page 10 .
E	Antenna: For use when controlling the fixture using wireless DMX (page 18).
F	Encoders (Red, Green, Blue): The colors of encoders correspond to options on the display. Press to activate the options at the bottom of the display, or turn to modify the values on the display.
G	NFC (Near Field Communication) tag: Use the Set Light app to wirelessly configure the fixture, with or without power applied to the fixture (page 18).
H	USB port: Use for updating firmware, saving and loading fixture configuration settings, or saving error logs via a flash drive. See Troubleshooting and Maintenance on page 20 .
I	UI lock: Set this switch to lock the UI. This prevents inadvertent changes to the UI. See Lock the Display on page 19 .

Set Up and Focus the Fixture



WARNING: Note the following safety warnings before use:

- Only use mounting hardware that is rated for the total weight of the fixture and accessories.
- In addition to primary suspension, attach a safety cable (or other approved safety device) to the fixture. Safety cables must be rated to support six times the fixture weight. See [Mount the Fixture below](#).
- Check that the accessory holder is locked and that any accessory safety cables are connected before mounting the fixture.

AVERTISSEMENT : Prendre connaissance des avertissements de sécurité suivants avant toute utilisation :

- N'utilisez que de la quincaillerie de montage adaptée au poids total des projecteurs et des accessoires.
- En plus de la suspension principale, fixez une chaîne de sécurité (ou tout autre dispositif de sécurité homologué) au projecteur. Les chaînes de sécurité doivent être en mesure de supporter six fois le poids du projecteur.
- Vérifiez que le porte-accessoires est verrouillé et que les élingues de tous les accessoires sont bien attachées avant de monter le projecteur.

Mount the Fixture

You can mount the fixture using a clamp, junior (28 mm) pin (included), or appropriate mounting hardware on the yoke, or you can set the fixture on the floor or another flat surface. When suspending the fixture, make sure to secure the fixture with appropriate safety cables at the safety cable attachment points on the small (PL8 or PD8) fixture or at the handles using a looped attachment on the medium (PL16 or PD16) and large (PL24 or PD24) fixtures.

Small (PL8 or PD8)
Attach safety cables to the connection points

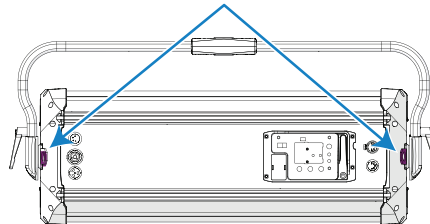

Medium (PL16 or PD16) and Large (PL24 or PD24)
Attach safety cables to either pair of handles using looped attachments (see inset)

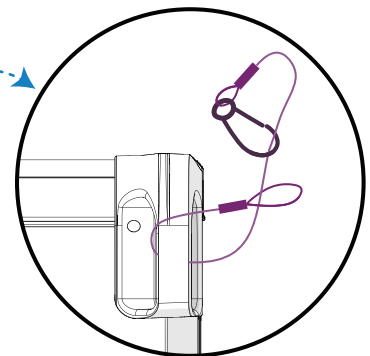
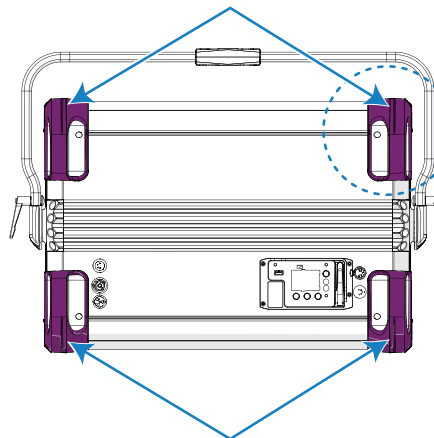

Add Accessories

You can use up to two standard accessories (one diffusion and one additional accessory, such as a barn door) in the accessory holder.

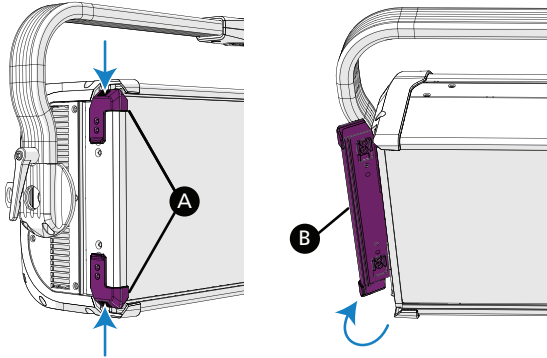

1. Unlock the accessory holder on either side by pressing and sliding both accessory holder locks (A), and then rotating the accessory holder door (B).
2. Slide an accessory into one of the accessory slots. You can add a second accessory in the other slot, if needed. For diffusion accessories, verify that the rough side of the diffusion faces the LEDs and that you can read the label text on the diffusion from the front of the fixture.
3. Lock the accessory holder by closing the door and sliding the locks back into position.

Connect Power and Data

1. Attach five-pin XLR cable to the DMX In connector (if using external control).
2. Plug the XLR cable (if using) into the DMX source or data daisy-chain.
3. Are you using AC power or battery power?
 - AC power: Continue to step 4.
 - Battery power: Continue to step 5.
4. Use the Power Thru and DMX Thru connectors to connect other fixtures using the following recommended guidelines:
 - Power Thru: Link a small (PL8 or PD8) fixture to up to three other small fixtures, or link a medium (PL16 or PD16) fixture to another medium fixture via Power Thru connector when using an R20 Relay Module, ER15 Relay Module, or Unison Echo Relay Panel (consult breaker-trip curves when using other equipment). When linking other combinations of fixtures, do not exceed the rating of the power connectors (20 A in 120 V/60 Hz regions and 16 A in 240 V/50 Hz regions).
 - DMX Thru: Connect up to 32 device loads on the DMX daisy chain.
5. Supply power to the fixture in one of these ways:
 - Attach the power cable to the Power In connector, and then plug the power cable into AC power (100–240 VAC, 50/60 Hz) on a non-dimmable circuit.
 - Attach the four-pin XLR cable to the Battery connector, and then plug the cable into the battery (24–36 VDC). (Battery input not available on PL24 or PD24.)

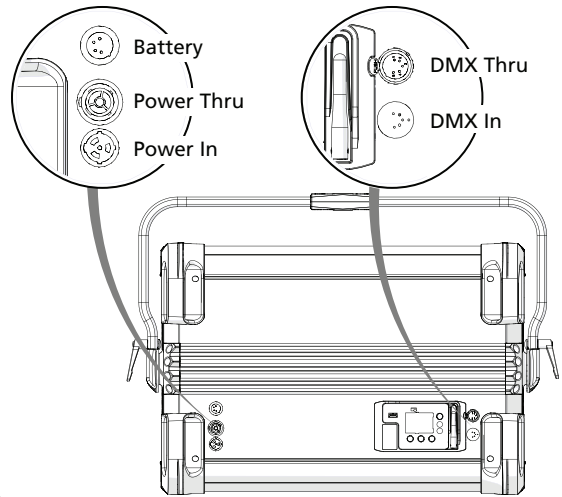

CAUTION: Do not connect the fixture to the battery when AC power is present. Maximum fixture output may be reduced when the fixture is connected to battery power.

Focus the Fixture

1. Apply power to the fixture, and wait until the fixture has booted up (the ETC splash screen displays during boot up).
2. Press any encoder to "wake" the display.
3. What screen is currently displayed?
 - **DMX:** Press the Intensity encoder to turn on the LED array. The display shows a timeout countdown to indicate how long the LED array will remain on at 100% intensity. You can turn the Intensity encoder to reset the timeout countdown to 5 minutes.
 - **All other screens (Studio, Preset, etc.):** Press the Intensity encoder to turn on the LED array, and turn the Intensity encoder to adjust the intensity.
4. Adjust the fixture to the desired position.
5. Press the Intensity encoder to turn off the LED array.

Use Fixture in DMX Mode

After you connect power and data to the fixture and provide DMX, press the **Function** button (Fn) repeatedly to toggle to the **DMX** screen, where you can set the DMX address, DMX mode, and DMX loss behavior. (You can also set these values using RDM.)

The **DMX** screen displays the current DMX values. Press any of the encoders to "wake" the display and edit the values. The colors of the encoders correspond to options on the display. Turn an encoder to modify the corresponding value.

After you wake the display, you can press the Intensity encoder to enter Focus mode. See [Focus the Fixture on the previous page](#).

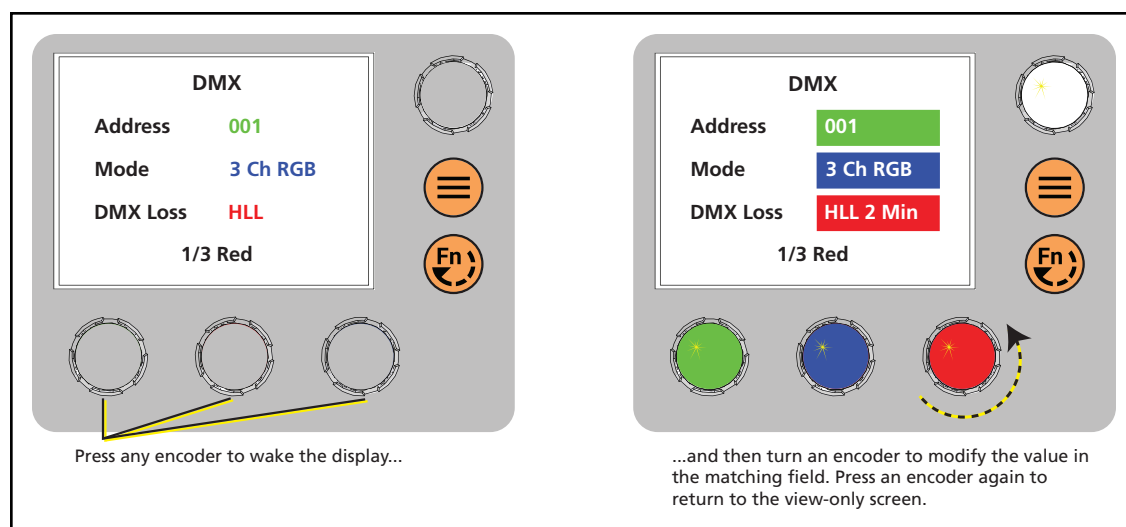

Set DMX Address

In the **DMX** screen, turn the green encoder to set the DMX address. The default address is 001.

Set DMX Mode

In the **DMX** screen, turn the blue encoder to set the DMX mode.

- **Direct:** Direct control of emitters.
- **Expanded:** Combines RGB control with Studio control. The **Mix** control channel in **Expanded** mode moves control from full **RGB** mode to full **Studio** mode.
- **Studio:** **CCT** (Correlated Color Temperature) control, **Tint** control (from -10 to 10 green), and metamer control ranging from **Brightest** to **Best Spectral**. This is the default mode for Daylight HDR fixtures.
- **3 Ch RGB:** Standard RGB control. In **RGB** mode, the **Curve** is always set to **Incandescent** and the **Fan** is always set to **Auto**. This is the default mode for Lustr X8 fixtures.
- **1 Channel:** Intensity control for preset 1. (See [Preset Mode on page 17](#).) In **1 Channel** mode, the **Curve** is always set to **Incandescent** and the **Fan** is always set to **Auto**.

DMX Modes

	Direct (Daylight HDR)	Direct (Lustr X8)	Expanded	Studio	3 Ch RGB	1 Channel
RDM Personality ID ►	1	1	2	3	4	5
DMX Channel ▼						
1	Intensity	Intensity	Intensity	Intensity	Red	Intensity
2	Deep Red	Deep Red	CCT*	CCT*	Green	
3	Red	Red	Tint*	Tint*	Blue	
4	Mint	Amber	Tuning*	Tuning*		
5	Cyan	Lime	Mix*	Strobe*		
6	Blue	Green	Red	Curve*		
7	Indigo	Cyan	Green	Fan*		
8	Strobe*	Blue	Blue			
9	Curve*	Indigo	Strobe*			
10	Fan*	Strobe*	Curve*			
11		Curve*	Fan*			
12		Fan*				

* See [DMX Control Channels below](#) for the DMX values that set these parameters.

DMX Control Channels

Parameter	DMX Value	Description	Comments
CCT	0	3200 K	
	1–165	1900–6000 K	CCT values increase by 25 for each DMX value (1 = 1900 K, 2 = 1925 K, etc.).
	166–254	6050–10,450 K	CCT values increase by 50 for each DMX value (166 = 6050 K, 167 = 6100 K, etc.).
	255	5600 K	
Curve	0–9	Incandescent	
	10–19	Linear	
	20–29	Incandescent Red Shift	In Direct Mode, the fixture uses Incandescent instead of Incandescent Red Shift.
	30–39	Linear Red Shift	In Direct Mode, the fixture uses Linear instead of Linear Red Shift.
	40–255	Reserved	All modes use Incandescent in the range of DMX values for Reserved.
Fan	0–9	Auto	
	10–19	Off	When the fixture gets too hot, the fixture reduces the intensity instead of turning on the fan.
	20	Slow	Minimum fan speed
	21–248	Linear Increase in Speed	
	249	Fast	Maximum fan speed (100%)
	250–255	Auto	
Mix	0	Full RGB	
	1–254	Linear interpolation from RGB to Studio	
	255	Full Studio	

Parameter	DMX Value	Description	Comments
Strobe	0	No Strobe	Shutter open
	1–40	Dark Strobe	Range is 1–40 Hz.
	41–80	Bright Strobe	Range is 1–40 Hz.
	81–120	Pulse Strobe	Strobe includes a fade up and fade down on each pulse.
	121–160	Random Strobe	Strobe pulses at random intervals.
	161–200	Flicker Effect	Strobe pulses at random intervals and at random intensity levels.
	201–240	No Strobe	Shutter open
	241–254	LEDs Off	Shutter closed
	255	No Strobe	Shutter open
Tint	0	Neutral	
	1–127	Linear between +10 and 0	Tint shifts toward green (+10) as the DMX value decreases to 1.
	128	Neutral	
	129–255	Linear between 0 and -10	Tint shifts toward magenta (-10) as the DMX value increases to 255.
Tuning (Color calculation method)	0–49	Brightest	Calculation uses a combination of LEDs to produce the brightest version of the selected chromaticity.
	50–99	Hybrid	Calculation is halfway between the Brightest and the Best Spectral Match of the selected chromaticity.
	100–149	Best Spectral Match	Calculation uses a combination of LEDs to produce the best spectral match of the selected chromaticity. The Best Spectral Match option results in higher color rendering, but lower intensity levels.
	150–255	Reserved	This range is reserved for future development, but currently outputs the Brightest color calculation method.

Set DMX Loss Behavior

In the **DMX** screen, turn the red encoder to set the DMX loss behavior. Options are:

- **Instant:** Immediately return to last look used in stand-alone mode. If no stand-alone look was selected, the fixture goes dark.
- **HLL 2min:** Hold last look for two minutes or until you make local changes. If you make no changes during the two minutes, the fixture fades out over two seconds.
- **HLL:** Hold last look until you make local changes. This is the default setting.
- **Preset 12:** Two-second fade from last look to Preset 12.

Use Fixture in Stand-alone Mode

After you connect power to the fixture, press the **Function** button () repeatedly to toggle through the following modes:

- **Studio:** Use one of three studio (white light) presets, or customize the presets.
- **Color:** Use one of 12 color presets, or customize the presets.
- **Preset:** Use one of 12 presets (color preset + fade time), or customize the presets.
- **Effects:** Use one of 12 effects, or customize the effects.
- **DMX:** View and set DMX parameters for the fixture.

The colors of options on the display correspond to the colors of the encoders below the display and the Intensity encoder to the right of the display. Turn an encoder to modify the corresponding value on the display, or press an encoder to activate the corresponding option at the bottom of the display. Press the Intensity encoder to toggle between the current intensity and 0%.

If the fixture is connected to other fos/4 Panel fixtures that are in the same stand-alone mode, the connected fixtures will play the same preset or effect.

If the fixture is receiving DMX, the DMX data overrides any stand-alone mode selections. When the fixture is no longer receiving DMX, then the stand-alone selections take effect.

Studio Mode

1. Press the **Function** button (Fn) until the display shows the **Studio** screen.

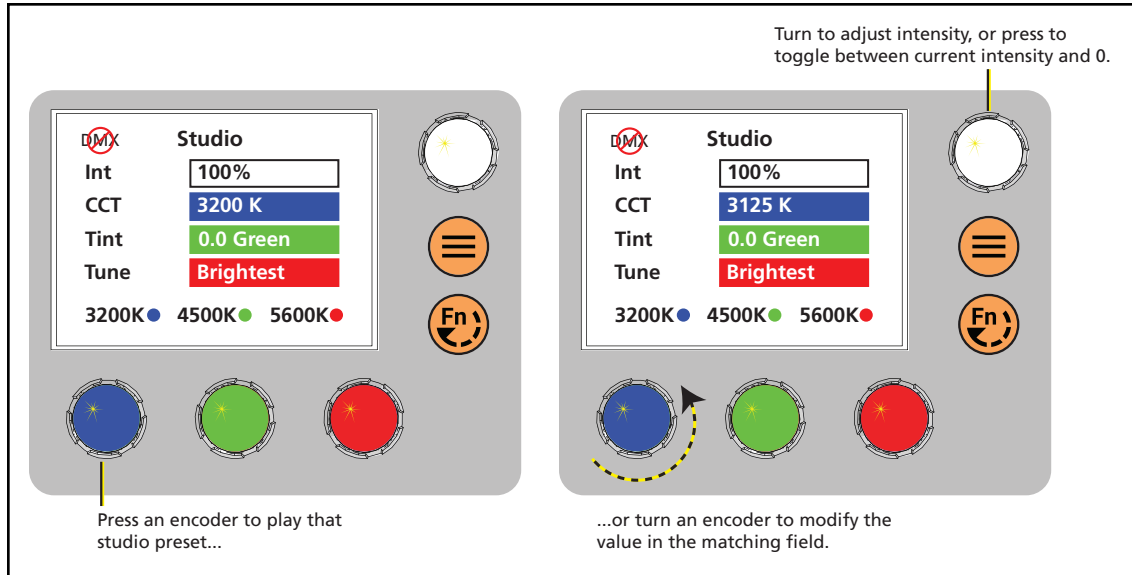

2. Press the color encoder that matches the studio preset you want to use.
 - Blue: 3200 K
 - Green: 4500 K
 - Red: 5600 K

More Options

- **Turn off** the preset: Press the Intensity encoder to toggle the intensity value from the current value to 0. Press the Intensity encoder again to toggle back to the previous intensity value.
- **Modify** the preset: Turn the encoders to change the corresponding values. For example, turn the Intensity encoder to change the intensity value, or turn the blue encoder to change the color temperature value.
- **Revert** to the original preset: Press the encoder that corresponds to the preset again to restore the original values.
- **Save** the modified preset: Press and hold the encoder that corresponds to the preset that you want to re-record. The display shows a three-second countdown before re-recording the preset.



Note: The *CCT*, *Tint*, and *Tune* values match the values that are available when the *DMX* mode is set to *Studio*. See [DMX Control Channels on page 11](#).

Color Mode

1. Press the **Function** button (Fn) until the display shows the **Color** screen.

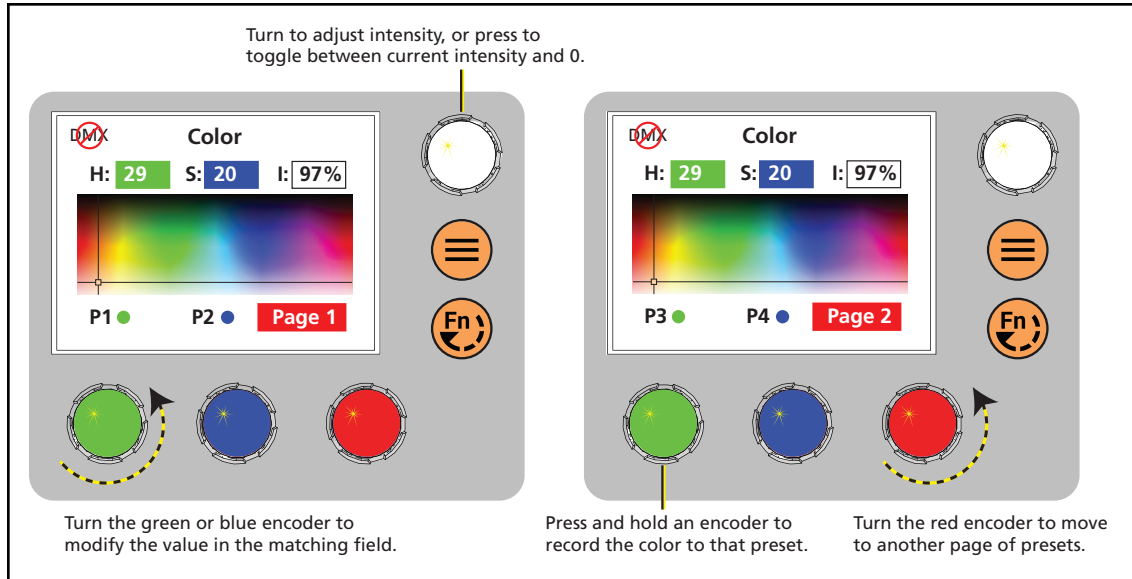

2. Turn the encoders to change the corresponding values. For example, turn the Intensity encoder to change the intensity value, or turn the green encoder to change the hue value. The crosshairs on the display indicate the approximate color.

You can use a preset as a starting point for a color by pressing the color encoder that matches the preset. Turn the red encoder to move to another page of presets.

Number	Preset
1	3200 K
2	4500 K
3	5600 K
4	Yellow
5	Dark Straw
6	Red

Number	Preset
7	Medium Pink
8	Magenta
9	Medium Blue
10	Primary Blue
11	Blue Green
12	Green

More Options

- **Turn off** the color: Press the Intensity encoder to toggle the intensity value from the current value to 0. Press the Intensity encoder again to toggle back to the previous intensity value.
- **Revert** to the original color of a preset: Press the encoder that corresponds to the preset again to restore the original values.
- **Save** the color to a preset: Press and hold the encoder that corresponds to the preset that you want to re-record. The display shows a three-second countdown before re-recording the preset. Changes that you make to presets in the **Color** screen also affect presets in the **Effects** screen and the **Preset** screen.

Effects Mode

1. Press the **Function** button (Fn) until the display shows the **Effects** screen.

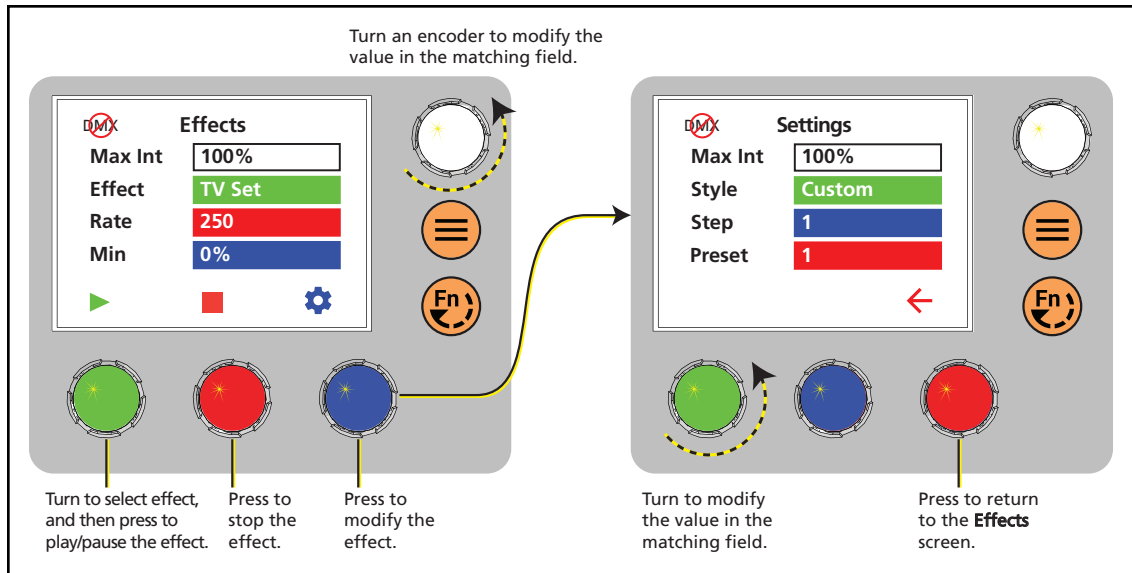

2. Turn the green encoder to select an effect, and then press the encoder to play the effect.

Effect	Description
Flicker	Fire or candle
Siren	Police or emergency vehicle lights
Lightning	Lightning strikes
Beacon	Rhythmic flashing
TV Set	Flickering television screen
Projector	Flickering film projector

Effect	Description
Camera	Paparazzi flashbulbs
Electrical	Occasional increases in intensity
Party	Rhythmic pulsing with bumps through colors
Fireworks	Bursts in random colors that fade
Explosion	Bursts in a selected color that fade
Sequence	Series of presets

More Options

- **Pause** the effect: Press the green encoder again. The green encoder toggles between play and pause. When you press the green encoder to play the effect again, the fixture resumes the effect from where you paused it.
- **Stop** the effect: Press the red encoder. When you press the green encoder to play the effect again, the fixture plays the effect from the beginning.
- **Modify** the effect: Turn the encoders to change the corresponding values. To modify the effect further, press the blue encoder (for the **Settings** icon ⚙️) to modify the settings for the effect.
- **Push** the effect to connected fixtures: Press the **Menu** button (☰), and then use the Intensity encoder to navigate through the menu: **Local Settings** > **Push Effects**. When the screen prompts you to confirm, press the green encoder (for the **OK** icon ✓) to continue.

Preset Mode

1. Press the **Function** button (Fn) until the display shows the **Preset** screen.

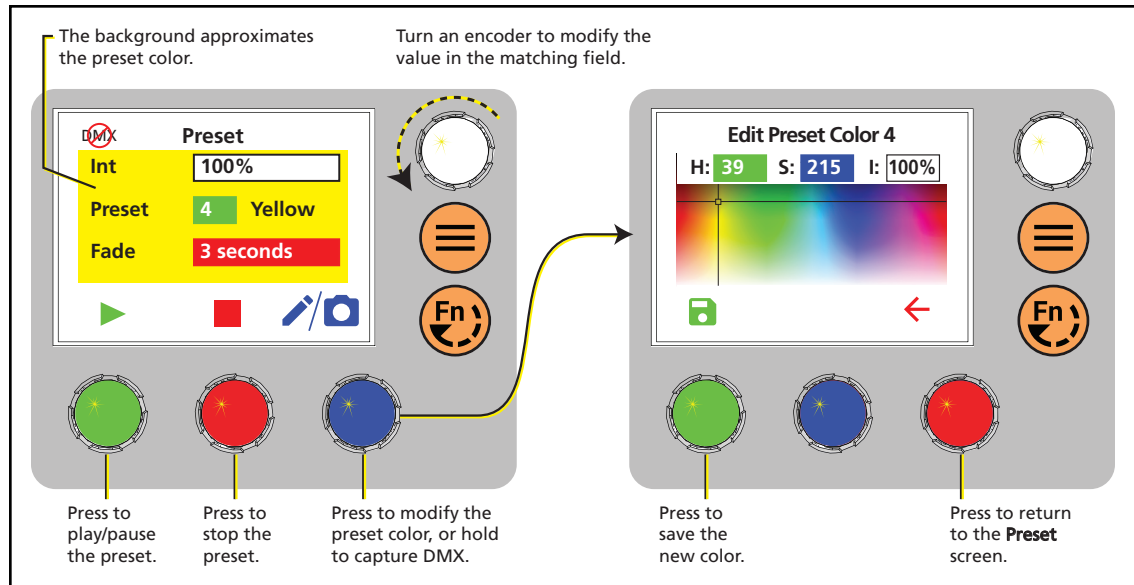

2. Turn the green encoder to select a preset, and then press the encoder to play the preset.

Number	Preset
1	3200 K
2	4500 K
3	5600 K
4	Yellow
5	Dark Straw
6	Red

Number	Preset
7	Medium Pink
8	Magenta
9	Medium Blue
10	Primary Blue
11	Blue Green
12	Green

More Options

- **Pause** the preset: Press the green encoder to toggle between play and pause.
- **Stop** the preset: Press the red encoder.
- **Modify** the preset: Turn the Intensity encoder to change the intensity, or turn the red encoder to change the fade value.
- **Capture** the current DMX look: Press and hold the blue encoder (for the **Snapshot** icon 📷). The display shows a 3-second countdown before re-recording the preset.
- **Modify** the preset **color**: Press the blue encoder (for the **Edit** icon ✏️). In the **Edit Preset Color** screen, turn the encoders to change the corresponding values. The crosshairs on the display indicate the approximate color. Press the green encoder (for the **Save** icon 💾) to save the new color to the preset.
- **Push** the preset to connected fixtures: Press the **Menu** button (☰), and then use the Intensity encoder to navigate through the menu: **Local Settings** > **Push Presets**. When the screen prompts you to confirm, press the green encoder (for the **OK** icon ✓) to continue.



Note: Changes that you make to presets in the **Preset** screen also affect presets in the **Color** screen and the **Effects** screen.

Set Up Wireless Control

Set Up Multiverse Wireless Communication

You can use a City Theatrical Multiverse® transmitting device to wirelessly configure the fixture and control the fixture in stand-alone modes. For information on using Multiverse products, see the documentation provided with the products.



Note: For additional guidance and troubleshooting resources when setting up your wireless system, download the *Wireless Fixture Setup Information Guide* at etcconnect.com.

To use Multiverse wireless communication, configure the Multiverse settings on the fixture.

1. Press the **Menu** button (☰), turn the Intensity encoder to navigate to **Multiverse Settings**, and then press the Intensity encoder to select it.
2. Turn the green encoder to enter the **SHoW ID** value. This value must match the SHoW ID value on the Multiverse transmitting device.
3. Turn the blue encoder to enter the **SHoW Key** value. This value must match the SHoW Key value on the Multiverse transmitting device.
4. Verify that the **On/Off** value is set to **On**. (If the value is set to **Off**, turn the red encoder to set the **On/Off** value to **On**.)
5. Press the green encoder for the **Save** button (☑) to save your settings, or press the red encoder for the **Cancel** button (✖) to discard your changes.

Control Fixtures Wirelessly Using the Set Light App

Download the Set Light app to a smartphone with NFC functionality, use the app to set fixture parameters, and then tap the smartphone to the NFC tag on the fixture to configure it wirelessly—even when the fixture is not powered on. Or, after you configure the Multiverse settings on the fixture, use the Set Light app to configure one fixture or multiple fixtures wirelessly from a smartphone or tablet. (You must be within Bluetooth range of the Multiverse transmitter or gateway in order to use the app in this mode.) Visit etcconnect.com/Apps for more information about the Set Light app.

Control and Customize the Display

Lock the Display

Set this switch to lock the UI and prevent any changes to the fixture setup. The display indicates when the UI is locked.

Adjust the Display Backlight and Display Timeout

1. Press the **Menu** button (☰), turn the Intensity encoder to navigate to **Local Settings**, and then press the Intensity encoder to select it.
2. In the **Local Settings** screen, turn the Intensity encoder to select the display parameter that you want to modify, and then press the Intensity encoder to modify it.
3. Turn the Intensity encoder to modify the value of the parameter, and then press the Intensity encoder to save the value.
4. Press the **Menu** button (☰) or press the red encoder until you return to the **Main Menu** screen when you are done.

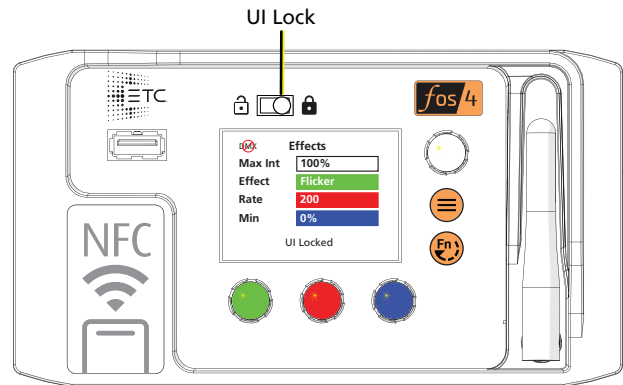

Parameter	Description
Backlight	Set the display backlight from 10%–100%.
Timeout	Set the time that the display will remain illuminated after the last time you press an encoder or button. Options are: <ul style="list-style-type: none">• Never (display is always illuminated)• 30 seconds• 1 minute (default)• 5 minutes• 15 minutes

Troubleshooting and Maintenance

Troubleshooting Checklist

If you cannot find the resources that you need in this document, contact ETC Technical Services (see [Help from ETC Technical Services on page 2](#)).

What I'm Seeing	What Might Be Wrong	What To Try
Color on the fixture does not match another fixture, or color on the fixture does not match expected color output	<ul style="list-style-type: none"> • Fixture is in Direct Mode (which is not a calibrated mode). • Color is out-of-gamut (error message displays). • Temperature sensor is failing. 	<ul style="list-style-type: none"> • Change to a calibrated DMX mode. All modes except Direct mode are calibrated modes. • Sending an out-of-gamut color to a fixture can result in differences in color output. Check the About Color screen to see if the color is out-of-gamut. See View Diagnostic Data on page 22. • If the temperature sensor is failing, contact ETC Technical Services for assistance.
Error message "Array Comm" or "Array Failure" displays on screen	Fixture cannot communicate with the LED array.	Contact ETC Technical Services.
Error message "Color Data Fail" displays on screen	Fixture cannot load its color information.	Contact ETC Technical Services.
Error message "LED High Temp" or "Power Budgeting" displays on screen	<ul style="list-style-type: none"> • Fan is set to a level that is too low for the current LED intensity. • Fan has failed. • Temperature sensor is failing. 	<ul style="list-style-type: none"> • Verify whether the fan is running. Check the About Sensors screen to view the current fan level. See View Diagnostic Data on page 22. • If the temperature sensor is failing, contact ETC Technical Services for assistance.
Error message "Low Battery" displays on screen	Fixture is powered by a battery, and the battery level is low.	Connect the fixture to a fresh battery. Follow the instructions provided with the battery to recharge the low-level battery (providing AC power to the fixture while the battery is connected does not recharge the battery).
<ul style="list-style-type: none"> • Error message "Multiverse Failure" displays on screen • Fixture is not responding to wireless control • Fixture is responding intermittently to wireless control 	<ul style="list-style-type: none"> • Fixture is still connected to wired DMX control (via DMX In connector). Wired DMX data takes precedence over wireless DMX data. • Other wireless systems are interfering with the Multiverse wireless communication. • Fixture antennas or Multiverse product antennas are not oriented optimally. • Multiverse transmitter is not located optimally. 	<p>See the <i>Wireless Fixture Setup Information Guide</i> for guidance on setting up wireless communication.</p> <ul style="list-style-type: none"> • Disconnect the DMX in cable. • Change the radio settings to different channels. Minimize overlap with other Wi-Fi sources. • Move the antennas on the fixtures, Multiverse products, or both. • Move the Multiverse transmitter.
Error message "No Bundle" displays on screen	Fixture does not have a firmware bundle stored internally. This may indicate that a firmware update failed.	Update the firmware again (see Update Firmware on page 24). If the error persists, contact ETC Technical Services.
Error message "USB Error" displays on screen	Fixture cannot read the USB flash drive.	Remove and the re-insert the USB flash drive. If the error message continues to display, try a different USB flash drive.
Fan is loud	DMX value for fan operation is set too high.	Verify that the DMX value is appropriate for the fan channel. See DMX Control Channels on page 11 .
Fixture is flickering	Fixture is receiving bad DMX.	Check the About Control screen to verify that the DMX controller is sending good DMX. See View Diagnostic Data on page 22 . If the DMX data looks good, then contact ETC Technical Services.
Fixture is stuck on the last look sent via DMX	The fixture may not be receiving DMX. (If you have not changed the DMX Loss behavior, the default setting is HLL , which causes the fixture to hold the last look until you make local changes.)	<ul style="list-style-type: none"> • Check the DMX In connector and cable. • Check that the DMX source is sending data.

Test the Emitters

As part of troubleshooting any issues with a fixture, you can test the emitters, either as a group or individually by color.

1. Press the **Menu** button (⊖), and then use the Intensity encoder to navigate through the menu: **Diagnostics > Test**.
2. In the **Test** screen, use the blue encoder to select the emitters to test, and the green encoder to set the level for the emitters:
 - Press the blue encoder to select all emitter colors, or turn the encoder to select an individual emitter color. (**De** = Deep red, **Re** = Red, etc.)
 - Press the green encoder to toggle between off and full (**FL**) for the selected emitters, or turn the encoder to set a specific level (0%–100%).
3. If necessary, use the Intensity encoder to set the intensity level for the emitter test.
4. Press the **Menu** button (⊖) or press the red encoder until you return to the **Main Menu** screen when you are done.



Note: If you don't press the **Menu** button (⊖) or press the red encoder to return to the **Main Menu** screen when you are done, the **Test** screen will time out based on the **Timeout** setting (see [Adjust the Display Backlight and Display Timeout on page 19](#)). However, if you set the **Timeout** setting to **Never** and do not exit the **Test** screen, the fixture will remain in test mode (overriding any other instructions to the fixture) until you return to the **Test** screen and exit it.

View Diagnostic Data

As part of troubleshooting any issues with a fixture, ETC Technical Services may ask that you view diagnostic data on the fixture.

1. Press the **Menu** button (⊖), turn the Intensity encoder to navigate to **Diagnostics**, and then press the Intensity encoder to select it.
2. In the **Diagnostics** screen, turn the Intensity encoder to select the diagnostics category, and then press the Intensity encoder to view the data for that category. Use the Intensity encoder in a given screen to navigate through the values in that screen.

Category	Description
About Fixture	Fixture data: <ul style="list-style-type: none">• Version numbers• Serial number• RDM ID• RDM Label
About Control	Information on the current DMX or Multiverse control data. Includes network statistics to aid in diagnosing DMX issues or connectivity issues.
About Sensors	<ul style="list-style-type: none">• Usage data for fixture power, fan, and battery.• Temperatures for the fixture components and fan usage; can aid in diagnosing issues with color mismatches between fixtures or overuse of fan.
Test	Use this option to test the emitters. See Test the Emitters above .
About Color	The target color sent to the fixture, the actual (current) color generated by the fixture, and whether the color sent to the fixture is out-of-gamut.
Events	Log of the last 50 changes to the fixture settings, identified by the source of the change (for example, via DMX, RDM, or the UI). The most recent change is first in the list. You can export the event log to a USB flash drive to aid in troubleshooting. See Export Fixture Event Log on page 24 .

3. Press the **Menu** button (⊖) or press the red encoder until you return to the **Main Menu** screen when you are done.

View Battery Level

1. Press the **Menu** button (⊖), turn the Intensity encoder to navigate to **Diagnostics**, and then press the Intensity encoder to select it.
2. In the **Diagnostics** screen, turn the Intensity encoder to select **About Sensors**, and then press the Intensity encoder to view the sensor data. The **Battery** field displays the current battery level.
3. Press the **Menu** button (⊖) or press the red encoder until you return to the **Main Menu** screen when you are done.

Set a Low Battery Warning



CAUTION: *Do not connect the fixture to the battery when AC power is present. Maximum fixture output may be reduced when the fixture is connected to battery power.*

When the fixture is using battery power and the battery power is low, the fixture can display an error and send a notification to RDM controllers. You can customize the voltage level for the low battery warning.

1. Press the **Menu** button (⊖), turn the Intensity encoder to navigate to **Local Settings**, and then press the Intensity encoder to select it.
2. In the **Local Settings** screen, turn the Intensity encoder to select **Battery Alarm**, and then press the Intensity encoder to modify it.
3. Turn the Intensity encoder to set the voltage level for the low battery warning, and then press the Intensity encoder to save the value.
4. Press the **Menu** button (⊖) or press the red encoder until you return to the **Main Menu** screen when you are done.

Export Fixture Data for Troubleshooting

As part of troubleshooting any issues with a fixture, ETC Technical Services may ask that you export fixture data to a USB flash drive and then send the data for further analysis.

Export Fixture Data

The fixture routinely saves data. You can export the data to a USB flash drive to aid in troubleshooting any issues with the fixture.

1. Insert the USB flash drive in the USB port on the rear of the fixture (see [User Interface on page 6](#)).
2. Press the **Menu** button (⊖), and then use the Intensity encoder to navigate through the menu: **Local Settings > USB > Save Data**.
3. The display shows the file name to be saved (for example, f4data00.xml). Press the green encoder (for the **Save** icon ) to save the file to the USB flash drive.

The display returns to the **USB** screen when the process is complete. The saved data includes the following parameters:

- Power consumption
 - Temperatures (PSU, Control, and LED)
 - Control mode
 - DMX parameters
 - Run time in hours
4. Remove the USB flash drive from the USB port.

Export Fixture Event Log

The fixture routinely saves the last 50 changes to the fixture settings in an event log. The log identifies the way in which the settings were changed (for example, whether the settings were changed using the UI or via RDM). You can export the event log to a USB flash drive to aid in troubleshooting any issues with the fixture.

1. Insert the USB flash drive in the USB port on the rear of the fixture (see [User Interface on page 6](#)).
2. Press the **Menu** button (☰), and then use the Intensity encoder to navigate through the menu: **Local Settings > USB > Save Events**.
3. The display shows the file name to be saved (for example, f4log00.xml). Press the green encoder (for the **Save** icon ) to save the file to the USB flash drive.

When the display returns to the **USB** screen, the process is complete, and the data is saved to a file on the USB flash drive.

4. Remove the USB flash drive from the USB port.

Restore Default Settings

1. Press the **Menu** button (☰), and then use the Intensity encoder to navigate through the menu: **Local Settings > Restore Defaults**.
2. When the screen prompts you to confirm, press the green encoder (for the **OK** icon ) to continue. The screen shows a confirmation message after default settings have been restored. After the default settings have been restored, Daylight HDR fixtures will be in stand-alone **Studio** mode, and the DMX mode for Lustr X8 fixtures will be **3 Ch RGB**.

Update Firmware

When fixtures are connected to data, you can update firmware directly using UpdaterAator. For information on UpdaterAator, see the *UpdaterAator Software QuickGuide*, which you can download from etcconnect.com.

You can also update firmware using a USB flash drive. After you update a single fixture using a USB flash drive, you can update all connected fixtures from that fixture.

Update a Single Fixture Using a USB Flash Drive

1. Use UpdaterAator to get the updated firmware file for the fixture, and then save the firmware file to a USB flash drive. For information on UpdaterAator, see the *UpdaterAator Software QuickGuide*, which you can download from etcconnect.com.
2. Insert the USB flash drive in the USB port on the rear of the fixture (see [User Interface on page 6](#)).
3. Press the **Menu** button (☰), and then use the Intensity encoder to navigate through the menu: **Local Settings > USB > Update Firmware**.
4. Use the Intensity encoder to navigate to the firmware update file, and then press the Intensity encoder to begin the firmware update. The firmware update includes several steps:
 - a. Copying the files to the fixture: A progress meter displays as the files are copied to the fixture.
 - b. Verifying the files: The ETC logo displays on the top half of the screen as the fixture verifies the files. You can safely remove the USB drive at this time.
 - c. Updating the fixture: The fixture installs the updated firmware files.

Update All Connected Fixtures

1. After you update the firmware on a fixture, verify that the fixture is not receiving DMX/RDM before you proceed.
2. Press the **Menu** button (☰) on the fixture, and then use the Intensity encoder to navigate through the menu: **Local Settings > Push Firmware**.
3. When the screen prompts you to confirm, press the green encoder (for the **OK** icon ✓) to continue. The updated firmware is copied to all connected fixtures, and the screens on connected fixtures display a progress message ("Firmware RX x%").

Backup and Restore the Fixture Configuration

You can save the fixture settings to a USB flash drive and then apply those settings to another fixture. You can also use the saved settings as a backup, and then apply the settings to the same fixture to restore it to a previous state.

Back Up Fixture Settings

1. Insert the USB flash drive in the USB port on the rear of the fixture (see [User Interface on page 6](#)).
2. Press the **Menu** button (☰), and then use the Intensity encoder to navigate through the menu: **Local Settings > USB > Save All Settings**.
3. The display shows the file name to be saved (for example, f4cfg00.xml). Press the green encoder (for the **Save** icon 📁) to save the file to the USB flash drive.
The display returns to the **USB** screen when the process is complete.
4. Remove the USB flash drive from the USB port.

Apply (or Restore) Fixture Settings

1. Insert the USB flash drive that contains the fixture settings file (f4cfgxx.xml) in the USB port on the rear of the fixture (see [User Interface on page 6](#)).
2. Press the **Menu** button (☰), and then use the Intensity encoder to navigate through the menu: **Local Settings > USB > Apply All Settings**.
3. When the screen prompts you to select the fixture settings file, use the Intensity encoder to navigate to the correct file and select it.
The display returns to the **USB** screen when the process is complete.
4. Remove the USB flash drive from the USB port.

Push Fixture Settings to All Connected Fixtures

1. Press the **Menu** button (☰), and then use the Intensity encoder to navigate through the menu: **Local Settings > Push Settings**.
2. When the screen prompts you to confirm, press the green encoder (for the **OK** icon ✓) to continue. The settings are copied to all connected fixtures, and the screens on connected fixtures display a confirmation message ("Config Received").

Clean the Diffusion

Clean the diffusion using a clean, micro-fiber cloth. You can use isopropyl alcohol on the cloth, but do not spray the cleaning solution directly onto the diffusion or into the interior of the fixture.



Note: For diffusion accessories, verify that the rough side of the diffusion faces the LEDs and that you can read the label text on the diffusion from the front of the fixture.

Specifications and Reference

For full product specifications, see the fos/4 Panel datasheet at etconnect.com.



Environment

The Panel operates in ambient temperatures of 0°C–40°C (32°F–104°F) and is rated IP20 (for use in dry locations only).

Fixture temperature information:

- Maximum recommended ambient operating temperature: $T_a=40^{\circ}\text{C}$ (104°F)
- Maximum anticipated external surface temperature: $T_{\text{max}}=80^{\circ}\text{C}$ (176°F)
- External temperature after 5 minutes of full-brightness operation at 25°C (77°F) ambient: 35°C (95°F)
- External Temperature (steady state achieved) at 25°C (77°F): 60°C (140°F)

Dimensions and Weight

Model	Array Type	Array Size	Weight
fos4PL8	Lustr X8	 20.3 x 61 cm (8 x 24 in)	14.5 kg (32 lb)
fos4PD8	Daylight HDR		
fos4PL16	Lustr X8	 40.6 x 61 cm (16 x 24 in)	25.4 kg (56 lb)
fos4PD16	Daylight HDR		
fos4PL24	Lustr X8	 61 x 61 cm (24 x 24 in)	35.8 kg (79 lb)
fos4PD24	Daylight HDR		

Electrical

- Operates between 100 VAC and 240 VAC at a frequency of 50/60 Hz.
- Requires power from a non-dimmable source.
- When not connected to AC power, the fixture can be powered by an external battery with a range of 24–36 VDC.
- Link a small (PL8 or PD8) fixture to up to three other small fixtures, or link a medium (PL16 or PD16) fixture to another medium fixture via Power Thru connector when using an R20 Relay Module, ER15 Relay Module, or Unison Echo Relay Panel (consult breaker-trip curves when using other equipment). When linking other combinations of fixtures, do not exceed the rating of the power connectors (20 A in 120 V/60 Hz regions and 16 A in 240 V/50 Hz regions).

Fixture	Maximum Power Consumption	Inrush (120 V)	Inrush (240 V)
PL8 and PD8	540 W	33.4 A	57 A
PL16 and PD16	1070 W	51 A	94.4 A
PL24 and PD24	1600 W	67.8 A	155 A

Typical Power Consumption		100 V	120 V	230 V
PL8 and PD8	Idle Power/Current	11.2 W/0.15 A	13.5 W/0.17 A	11.7 W/0.15 A
	Direct at Full/Current	480 W/4.9 A	475 W/4 A	465 W/2.1 A
PL16 and PD16	Idle Power/Current	17.4 W/0.25 A	19.5 W/0.26 A	18.3 W/0.29 A
	Direct at Full/Current	965 W/10 A	955 W/8.2 A	935 W/4.2 A
PL24 and PD24	Idle Power/Current	27.4 W/0.4 A	28.8 W/0.45 A	28.7 W/0.49 A
	Direct at Full/Current	1470 W/15.4 A	1475 W/12.4 A	1430 W/6.3 A

RDM Parameters

Parameter	Fixture	Value	Description
Manufacturer ID	All	0x6574	Electronic Theatre Controls
Model ID	fos4PL8	0x0400	ETC fos/4 Small Panel Lustr
	fos4PD8	0x0401	ETC fos/4 Small Panel Daylight
	fos4PL16	0x0410	ETC fos/4 Medium Panel Lustr
	fos4PD16	0x0411	ETC fos/4 Medium Panel Daylight
	fos4PL24	0x0420	ETC fos/4 Large Panel Lustr
	fos4PD24	0x0421	ETC fos/4 Large Panel Daylight
DMX Personality	All	0x00E0	1 = Direct 2 = Expanded 3 = Studio 4 = RGB 5 = 1-channel
DMX Start Address	All	0x00F0	Range = 1–512

Fixture Compliance

- cETLus Listed
- Conforms to UL 1573
- Certified to CAN/CSA C22.2 No. 166
- Conforms to EN60598-1 and EN60598-2-17

Wireless Radio Compliance

Contains: FCC ID VU65995, IC ID 7480A-5995

FCC Statement

This device complies with part 15 of the FCC Rules. Operation is subject to the following two conditions:

1. This device may not cause harmful interference and
2. This device must accept any interference received, including any interference that may cause undesired operation.

IC Statement

This device complies with Industry Canada's license-exempt RSSs. Operation is subject to the following two conditions:

1. This device may not cause interference; and
2. This device must accept any interference, including interference that may cause undesired operation of the device.

Le présent appareil est conforme aux CNR d'Industrie Canada applicables aux appareils radio exempts de licence. L'exploitation est autorisée aux deux conditions suivantes :

1. l'appareil ne doit pas produire de brouillage, et
2. l'utilisateur de l'appareil doit accepter tout brouillage radioélectrique subi, même si le brouillage est susceptible d'en compromettre le fonctionnement.

EU Declaration of Conformity

This product complies with the Essential requirements of the R&TTE Directive of the European Union (1999/5/EC).

This product conforms to the following standards:

- ETSI EN 300 328 V1.8.1 (2012-06)
- ETSI EN 301-489-1 V1.9.2 (2011-09)
- ETSI EN 301-489-17 V2.2.1 (2012-09)



Corporate Headquarters Middleton, WI, USA +1 608 831 4116 London, UK +44 (0)20 8896 1000
Holzkirchen, DE +49 (80 24) 47 00-0 Rome, IT +39 (06) 32 111 683 Hong Kong +852 2799 1220 Paris, FR +33 1 4243 3535
Web etccconnect.com Support support.etccconnect.com Contact etccconnect.com/contactETC
© 2020 Electronic Theatre Controls, Inc. Trademark and patent info: etccconnect.com/ip
Product information and specifications subject to change. ETC intends this document to be provided in its entirety.
7471M1200-1.0.0 Rev A Released 2020-01